

Silicon Carbide (SiC) Module – EliteSiC Power Module for Traction Inverter, Single-Side Direct Cooling, 2.2 mohm, 900 V, 6-Pack

NVXR22S90M2SPC

Product Description

The NVXR22S90M2SPC is part of the EliteSiC power module for traction inverter, a revolutionary high mobility compound semiconductor product family that offers increased performance, better efficiency, and higher power density in similar and highly compatible packaging solutions.

The module integrates 900 V SiC MOSFET in a 6-pack configuration. For assembly ease and reliability, a new generation of press-fit pins are integrated into the power module for signal terminals. In addition, it also integrates an optimized pin-fin heatsink in the baseplate.

To enhance reliability and thermal performance, sintering technology is applied for die attach. The module is designed to meet AQG324 automotive standard.

Features

- Direct Cooling w/ integrated Pin-fin Heatsink
- Silicon Nitride Isolator
- $T_{vj,Max} = 175^{\circ}C$ for Continuous Operation
- Automotive Grade SiC MOSFET Chip Technologies
- Sintered Die Technology for High Reliability Performance
- Easy to Integrate 6-pack Topology
- Automotive Module AQG324 Compliant
- These Devices are Pb-Free and are RoHS Compliant

Typical Applications

- Hybrid and Electric Vehicle Traction Inverter

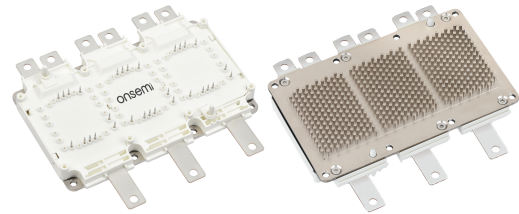

SSDC39 154.40x92.0 (SPC)
CASE 183AL

MARKING DIAGRAM

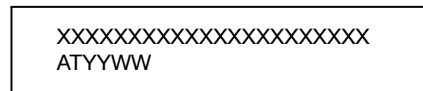

XXXXX = Specific Device Code
AT = Assembly & Test Site Code
YYWW = Year and Work Week Code

PIN DESCRIPTION

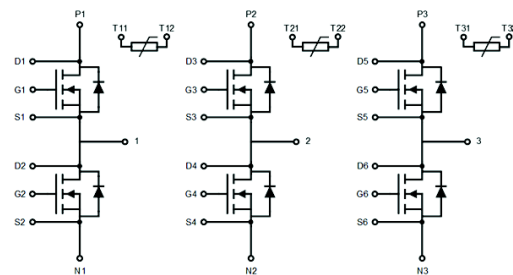

ORDERING INFORMATION

Device	Package	Shipping
NVXR22S90M2SPC	SSDC39 (Pb-Free)	4 Units / Tray

NVXR22S90M2SPC

Pin Description

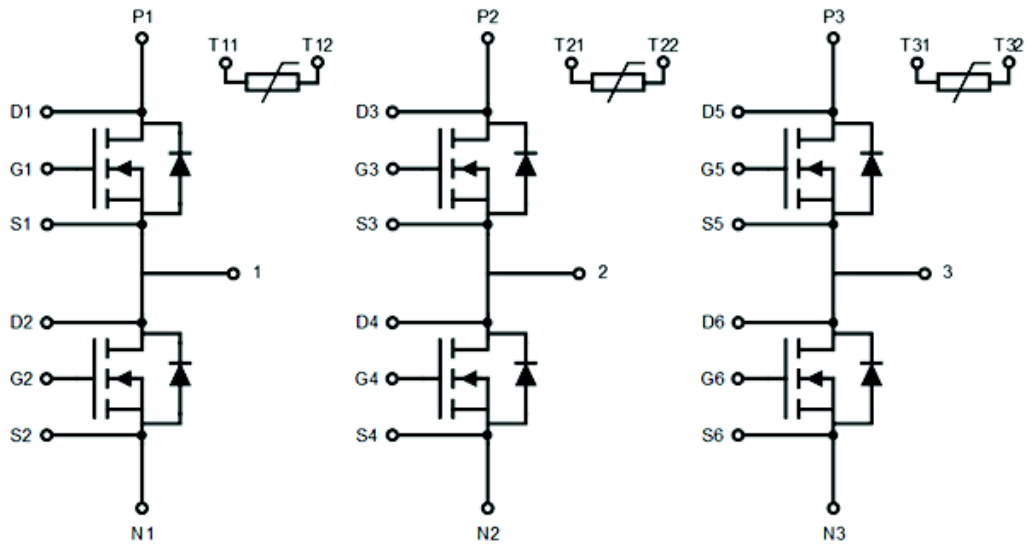

Figure 1. Pin Description

PIN FUNCTION DESCRIPTION

Pin #	Pin Function Description
P1, P2, P3	Positive Power Terminals
N1, N2, N3	Negative Power Terminals
1	Phase 1 Output
2	Phase 2 Output
3	Phase 3 Output
G1 – G6	SiC MOSFET Gate
S1 – S6	SiC MOSFET Source / Gate Return
D1 – D6	SiC MOSFET Drain Sense
T11, T12	Phase 1 Temperature Sensor Output
T21, T22	Phase 2 Temperature Sensor Output
T31, T32	Phase 3 Temperature Sensor Output

Materials

DBC Substrate: Si₃N₄ isolated substrate, basic isolation
 Terminals: Copper + Tin electro-plating
 Signal Leads: Copper + Tin plating
 Pin-fin Base plate: Copper + Ni plating

Flammability Information

The module frame meets UL94V-0 flammability rating

NVXR22S90M2SPC

MODULE CHARACTERISTICS ($T_{vj} = 25^{\circ}\text{C}$, Unless Otherwise Specified)

Symbol	Parameter	Rating	Unit
T_{vj}	Operating Junction Temperature	-40 to 175	$^{\circ}\text{C}$
T_{STG}	Storage Temperature Range	-40 to 125	$^{\circ}\text{C}$
V_{ISO}	Isolation Voltage (AC, 50 Hz, 5 s)	4200	V
L_{SDS}	Stray Inductance	8.5	nH
R_{DD+SS}	Module Lead Resistance, Terminals–Chip	0.77	$\text{m}\Omega$
G	Module Weight	700	g
CTI	Comparative Tracking Index	>200	–
d_{creep}	Creepage: Terminal to Heatsink Terminal to Terminal	9.0 9.0	mm
d_{clear}	Clearance: Terminal to Heatsink Terminal to Terminal	4.5 4.5	mm

Symbol	Parameters	Conditions	Min	Typ	Max	Unit
Δp	Pressure Drop in Cooling Circuit	10 L/min, 65°C , 50/50 EGW	–	95	–	mbar
P (Note 1)	Maximum Pressure in Cooling Loop (relative)	$T_{\text{Baseplate}} < 40^{\circ}\text{C}$ $T_{\text{Baseplate}} > 40^{\circ}\text{C}$	– –	– –	2.5 2.0	bar

1. EPDM rubber 50 durometer 'O' ring used.

ABSOLUTE MAXIMUM RATINGS ($T_{vj} = 25^{\circ}\text{C}$, Unless Otherwise Specified)

Symbol	Parameter	Rating	Unit
V_{DS}	Drain–to–Source Voltage	900	V
V_{GS}	Gate–to–Source Voltage	+22/–8	V
I_{DS}	Continuous DC Drain Current, $V_{GS} = 18\text{ V}$, $T_{vj} = 175^{\circ}\text{C}$, $T_F = 65^{\circ}\text{C}$ @ 10LPM, $R_{thj_F,max}$ (Note 2)	510	A
$I_{DS,pulsed}$	Pulsed Drain Current @ $V_{GS} = 18\text{ V}$, limited by $T_{vj,Max}$	1020	A
$I_{SD,BD}$	Continuous DC Body Diode Current, $V_{GS} = -5\text{ V}$, $T_{vj} = 175^{\circ}\text{C}$, $T_F = 65^{\circ}\text{C}$ @ 10LPM, using Ref. Heatsink (Note 2)	230	A
$I_{SD,pulsed}$	Pulsed Body Diode Current, $V_{GS} = -5\text{ V}$, limited by $T_{vj,Max}$	1020	A
P_{tot}	Total Power Dissipation $T_{vj,Max} = 175^{\circ}\text{C}$, $T_F = 65^{\circ}\text{C}$, Ref. Heatsink (typ)	900	W

Stresses exceeding those listed in the Maximum Ratings table may damage the device. If any of these limits are exceeded, device functionality should not be assumed, damage may occur and reliability may be affected.

2. Verified by characterization/design, not by test.

NVXR22S90M2SPC

MOSFET CHARACTERISTICS ($T_{vj} = 25^{\circ}\text{C}$, Unless Otherwise Specified)

Symbol	Parameters	Conditions	Min	Typ.	Max	Unit	
$R_{DS(ON)}$	Drain – Source On Resistance	$V_{GS} = 18\text{ V}$, $I_D = 510\text{ A}$	$T_{vj} = 25^{\circ}\text{C}$ $T_{vj} = 175^{\circ}\text{C}$	– 2.20 3.10	2.70 –	$\text{m}\Omega$	
I_{DSS}	Zero Gate Voltage Drain Current	$V_{GS} = 0\text{ V}$, $V_{DS} = 900\text{ V}$	$T_{vj} = 25^{\circ}\text{C}$ $T_{vj} = 175^{\circ}\text{C}$	– 2	600 –	μA mA	
I_{GSS}	Gate – Source Leakage Current	$V_{GS} = 18\text{ V}$, $V_{DS} = 0\text{ V}$		–	6	μA	
$V_{GS(TH)}$	Threshold Voltage	$V_{GS} = V_{DS}$, $I_D = 150\text{ mA}$		1.8	2.7	V	
g_{fs}	Forward Transconductance	$V_{DS} = 20\text{ V}$, $I_D = 510\text{ A}$		–	300	S	
Q_G	Total Gate Charge	$V_{GS} = -5/18\text{ V}$, $V_{DS} = 400\text{ V}$, $I_D = 510\text{ A}$		–	1.8	μC	
$R_{g,int}$	Internal gate resistance			–	0.9	Ω	
C_{iss}	Input Capacitance	$V_{DS} = 400\text{ V}$, $V_{GS} = 0\text{ V}$, $f = 100\text{ kHz}$		–	35	nF	
C_{oss}	Output Capacitance			–	2.5	nF	
C_{rss}	Reverse Transfer Capacitance			–	0.2	nF	
$T_{d,on}$	Turn on delay, inductive load	$I_D = 510\text{ A}$, $V_{DS} = 400\text{ V}$, $V_{GS} = +18 / -5\text{ V}$, $R_{g,on} = 5.0\ \Omega$	$T_{vj} = 25^{\circ}\text{C}$ $T_{vj} = 175^{\circ}\text{C}$	– –	106 88	– –	ns
T_r	Rise time, inductive load		$T_{vj} = 25^{\circ}\text{C}$ $T_{vj} = 175^{\circ}\text{C}$	– –	94 94	– –	ns
$T_{d,off}$	Turn off delay, inductive load	$I_D = 510\text{ A}$, $V_{DS} = 400\text{ V}$, $V_{GS} = +18 / -5\text{ V}$, $R_{g,off} = 2.4\ \Omega$	$T_{vj} = 25^{\circ}\text{C}$ $T_{vj} = 175^{\circ}\text{C}$	– –	295 345	– –	ns
T_f	Fall time, inductive load		$T_{vj} = 25^{\circ}\text{C}$ $T_{vj} = 175^{\circ}\text{C}$	– –	48 59	– –	ns
E_{on}	Turn On Switching Loss (including diode reverse recovery loss)	$I_D = 510\text{ A}$, $V_{DS} = 400\text{ V}$, $V_{GS} = +18 / -5\text{ V}$, $L_S = 19\text{ nH}$, $R_{g,on} = 5.0\ \Omega$	$di/dt = 4.2\text{ A/ns}$, $T_{vj} = 25^{\circ}\text{C}$	–	14	–	mJ
			$di/dt = 4.7\text{ A/ns}$, $T_{vj} = 175^{\circ}\text{C}$	–	12	–	
E_{off}	Turn Off Switching Loss	$I_D = 510\text{ A}$, $V_{DS} = 400\text{ V}$, $V_{GS} = +18 / -5\text{ V}$, $L_S = 19\text{ nH}$, $R_{g,off} = 2.4\ \Omega$	$dv/dt = 6.1\text{ V/ns}$ $T_{vj} = 25^{\circ}\text{C}$	–	12	–	mJ
			$dv/dt = 6.1\text{ V/ns}$ $T_{vj} = 175^{\circ}\text{C}$	–	13	–	
E_{SC}	Short Circuit Energy withstand	$V_{GS} = 18\text{ V}$, $V_{DD} = 400\text{ V}$	$T_{vj} = 25^{\circ}\text{C}$ $T_{vj} = 175^{\circ}\text{C}$	– –	8.7 7.0	– –	J

NVXR22S90M2SPC

BODY DIODE CHARACTERISTICS ($T_{vj} = 25^{\circ}\text{C}$, Unless Otherwise Specified)

Parameters		Conditions	Min	Typ	Max	Unit
V_{SD}	Diode Forward Voltage	$V_{GS} = -5\text{ V}$, $I_{SD} = 230\text{ A}$		4.0 3.5	-	V
E_{rr}	Reverse Recovery Energy	$I_{SD} = 510\text{ A}$, $V_R = 400\text{ V}$, $V_{GS} = -5\text{ V}$, $R_{g,on} = 5.0\ \Omega$		0.4 1.0	-	mJ
Q_{rr}	Recovered Charge			2.4 3.0	-	μC
I_{rr}	Peak Reverse Recovery Current			113 168	-	A

NTC SENSOR CHARACTERISTICS ($T_{vj} = 25^{\circ}\text{C}$, Unless Otherwise Specified)

Parameters		Conditions	Min	Typ	Max	Unit
R_{25}	Rated Resistance	$T_c = 25^{\circ}\text{C}$	-	5	-	$\text{k}\Omega$
$\Delta R/R$	Deviation of R_{25}	$T_c = 25^{\circ}\text{C}$, $R_{25} = 5\text{ k}\Omega$	-5	-	5	%
P_{25}	Power Dissipation	$T_c = 25^{\circ}\text{C}$	-	-	25	mW
$B_{25/50}$	B-Value	$R = R_{25} \exp [B_{25/50} (1/T - 1/298)]$	-	3375	-	K
$B_{25/80}$	B-Value	$R = R_{25} \exp [B_{25/80} (1/T - 1/298)]$	-	3411	-	K
$B_{25/120}$	B-Value	$R = R_{25} \exp [B_{25/120} (1/T - 1/298)]$	-	3433	-	K

THERMAL CHARACTERISTICS

Symbol	Parameter	Test Conditions	Min	Typ	Max	Unit
$R_{th,J-F}$	FET Junction to Fluid	R_{th} , Junction to Fluid, 10 L/min, 65°C , 50/50 EGW	-	0.12	0.131	$^{\circ}\text{C}/\text{W}$

TYPICAL CHARACTERISTICS

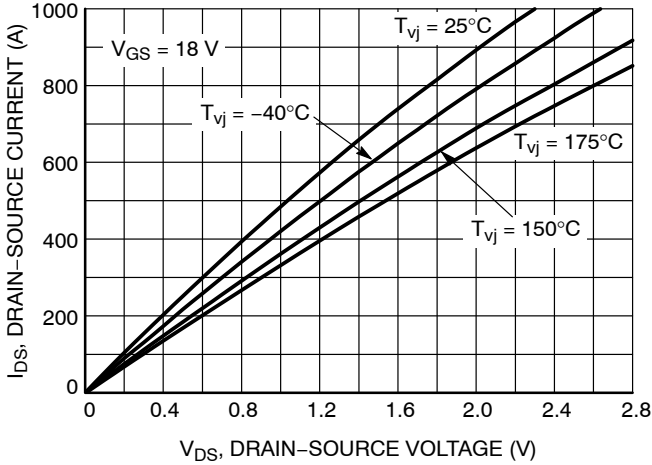

Figure 2. Output Characteristics

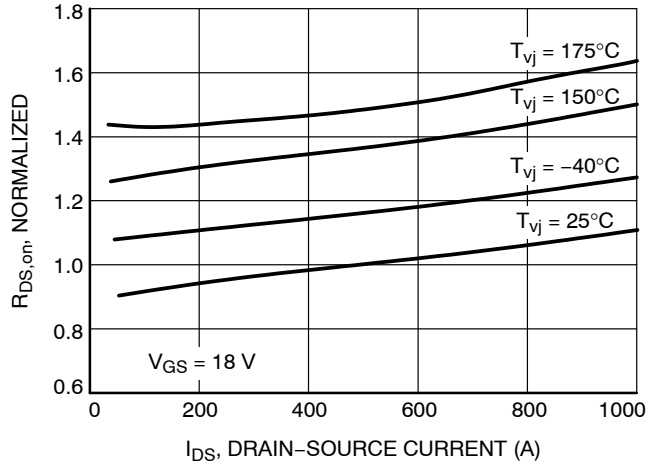

Figure 3. Normalized On-state Resistance vs. Drain Current

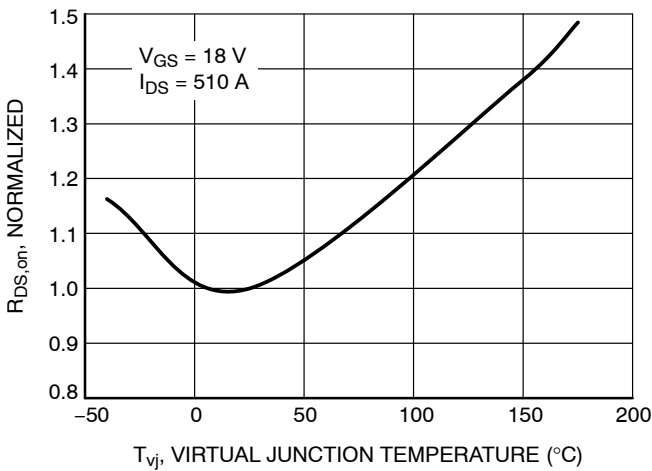

Figure 4. Normalized On-state Resistance vs. Temperature

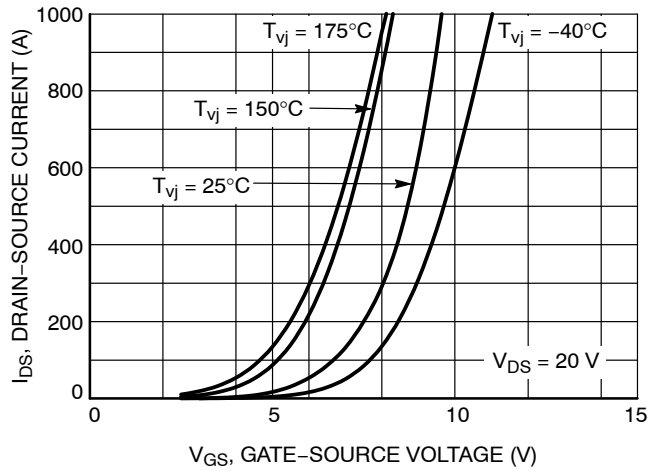

Figure 5. Transfer Characteristic

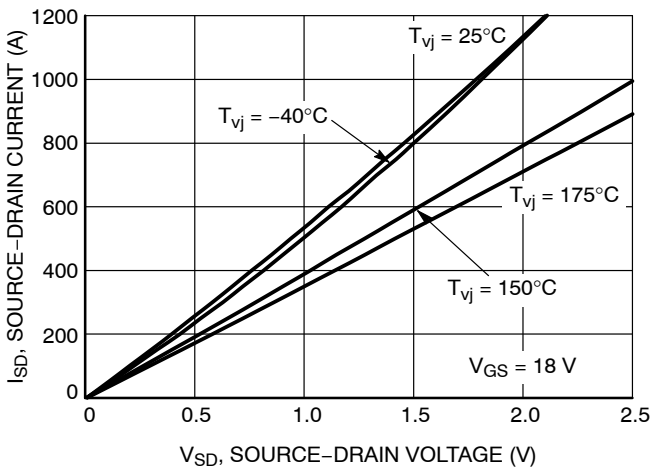

Figure 6. 3rd Quadrant Characteristic at $V_{GS} = 18\text{ V}$

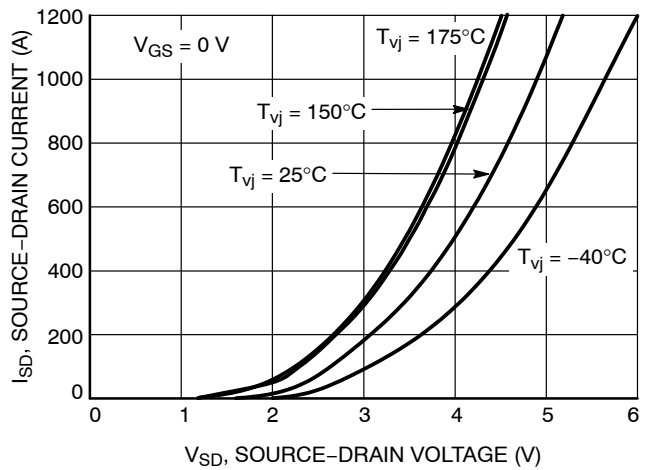

Figure 7. 3rd Quadrant Characteristic at $V_{GS} = 0\text{ V}$

NVXR22S90M2SPC

TYPICAL CHARACTERISTICS

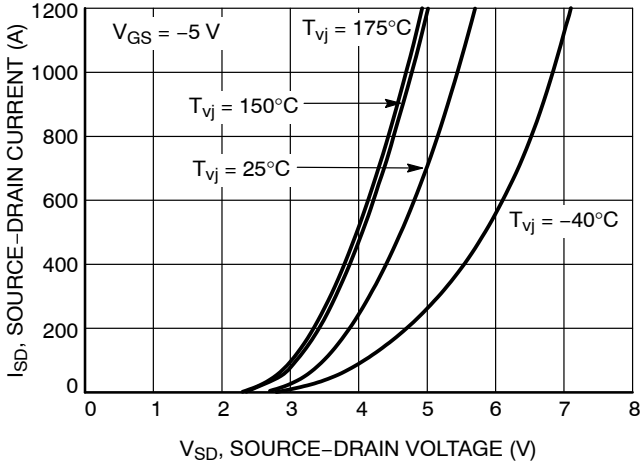

Figure 8. 3rd Quadrant Characteristic at $V_{GS} = -5\text{ V}$

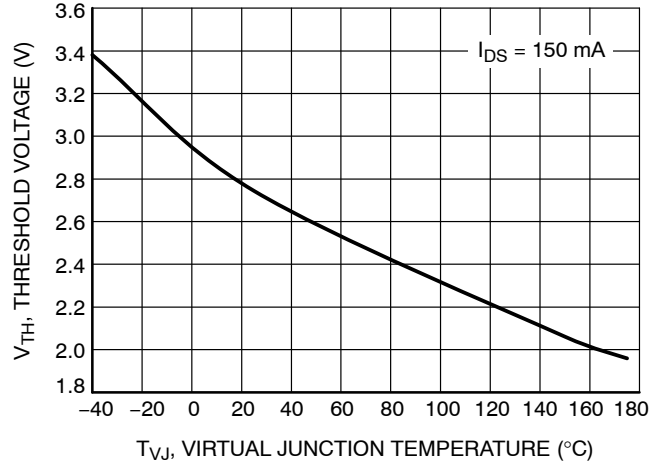

Figure 9. Gate Threshold Voltage vs. Temperature

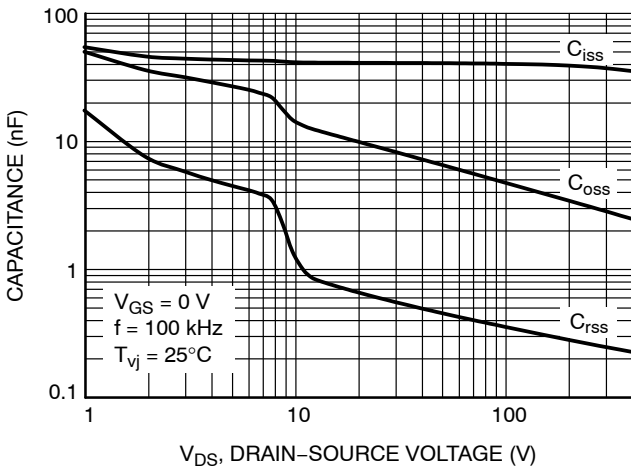

Figure 10. Typical Capacitance vs. Drain-Source Voltage

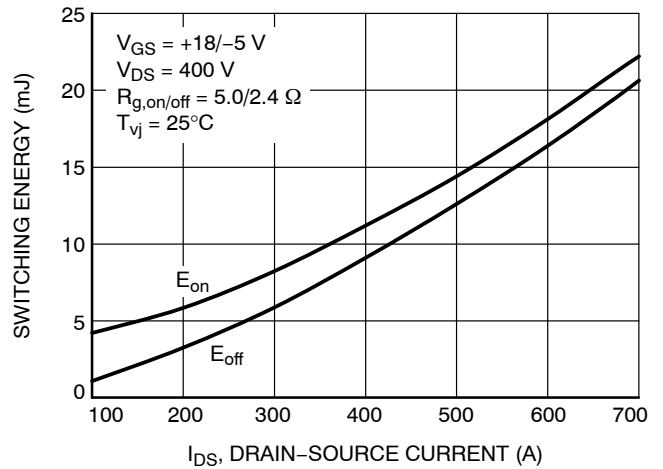

Figure 11. Switching Energies at 25°C

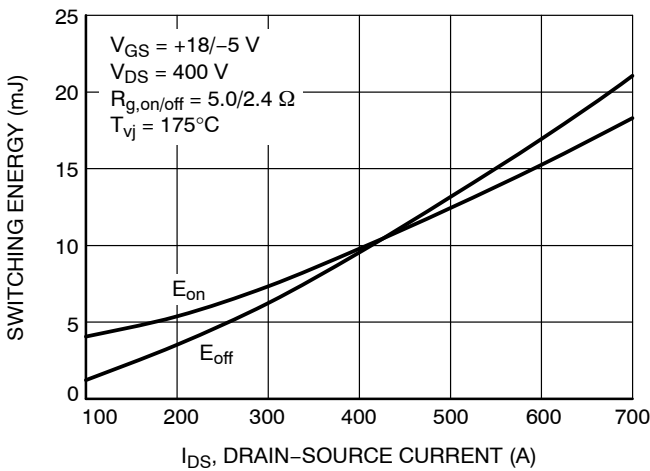

Figure 12. Switching Energies at 175°C

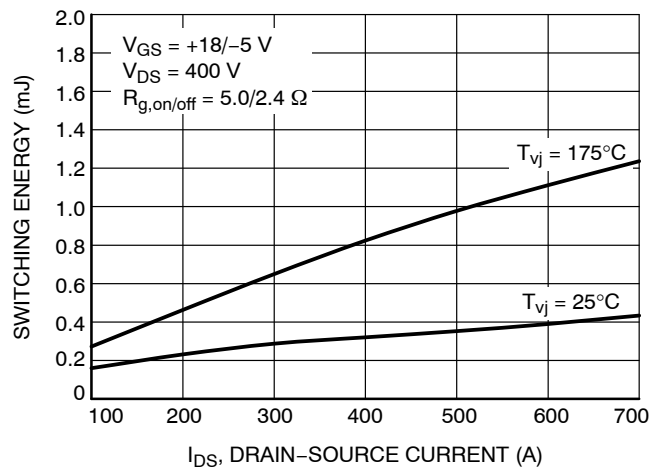

Figure 13. Reverse Recovery Energy vs. Drain-Source Current

NVXR22S90M2SPC

TYPICAL CHARACTERISTICS

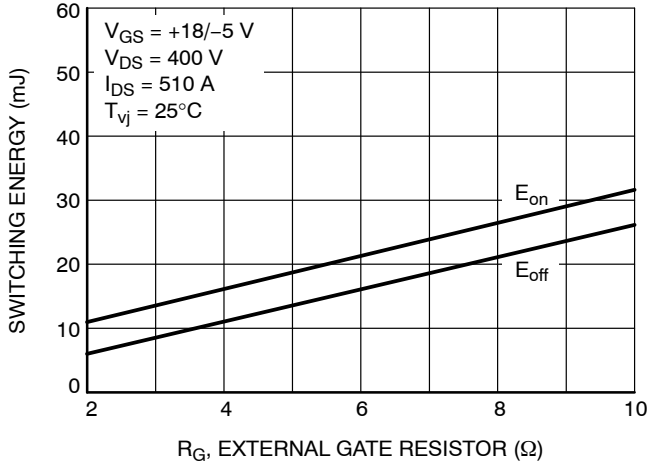

Figure 14. Switching Energies vs. External Gate Resistor

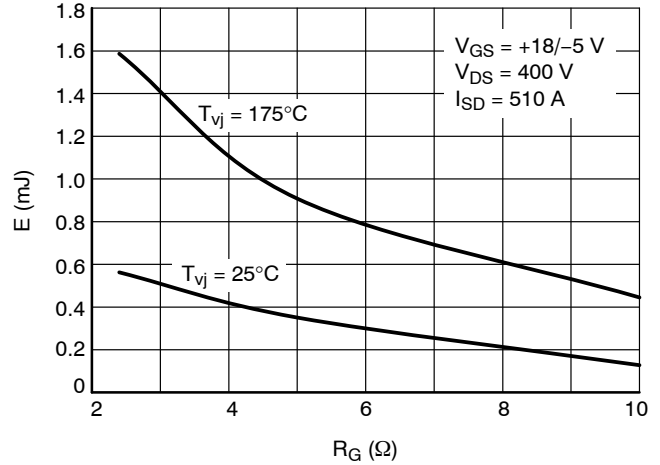

Figure 15. Reverse Recovery Energy vs. External Gate Resistor

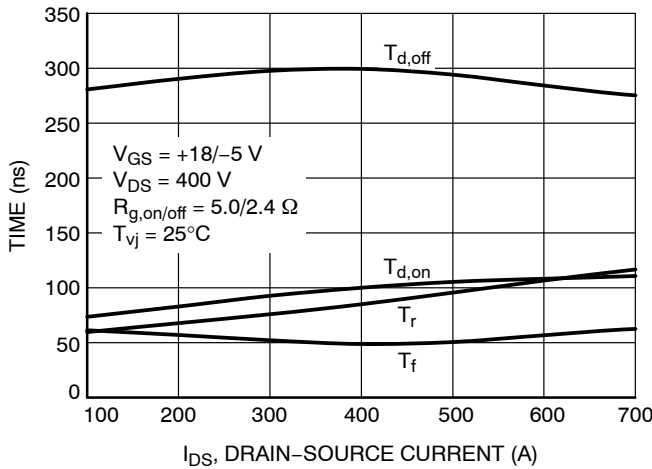

Figure 16. Timing Characteristics vs. Drain-Source Current

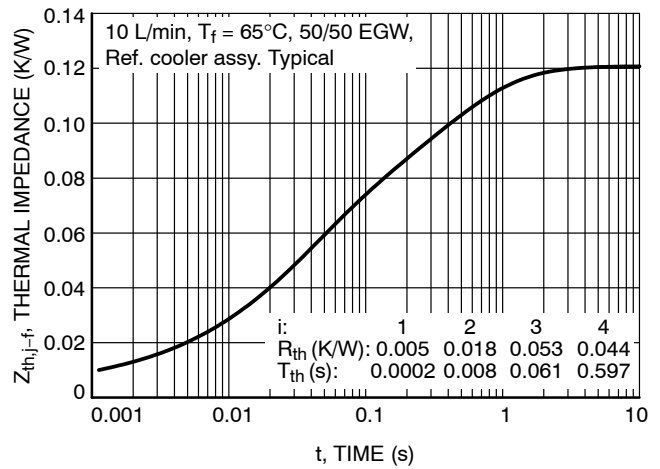

Figure 17. Typical Thermal Impedance, Junction to Fluid

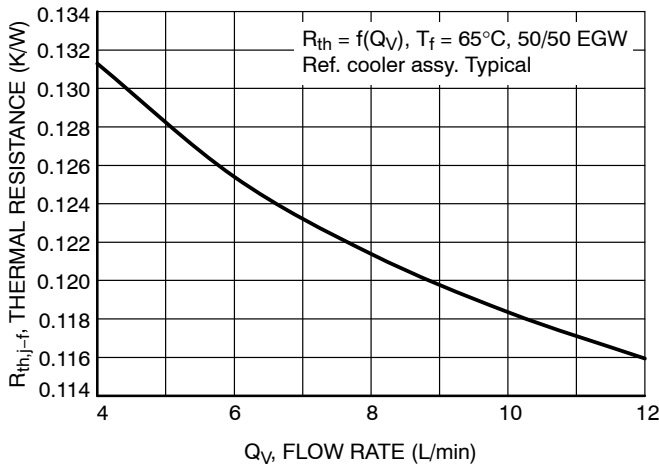

Figure 18. Typical Thermal Resistance vs. Flow Rate

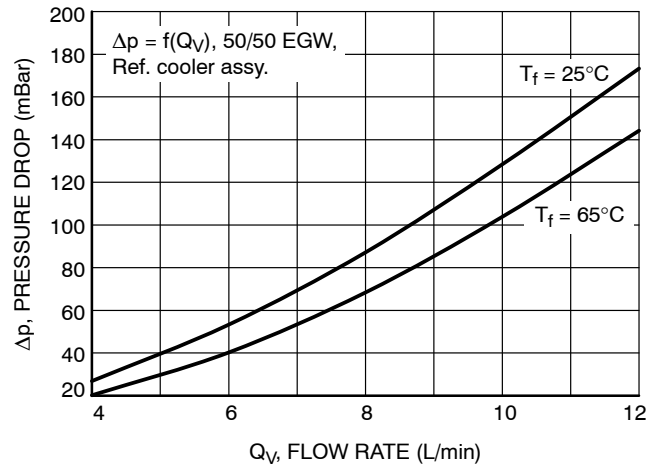

Figure 19. Pressure Drop in Cooling Circuit

NVXR22S90M2SPC

TYPICAL CHARACTERISTICS

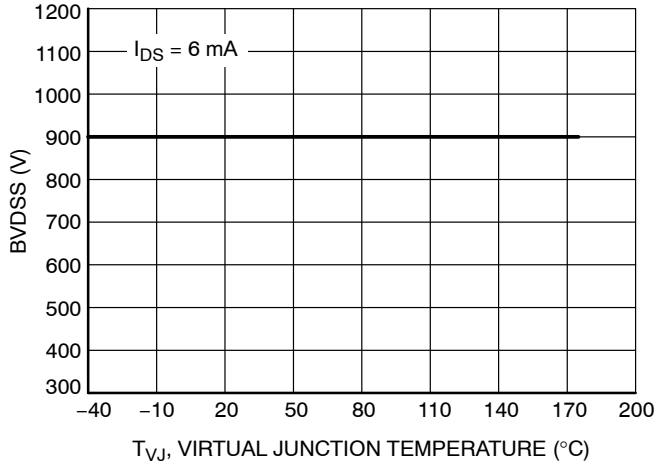

Figure 20. MOSFET Breakdown Voltage vs. T_{vj}

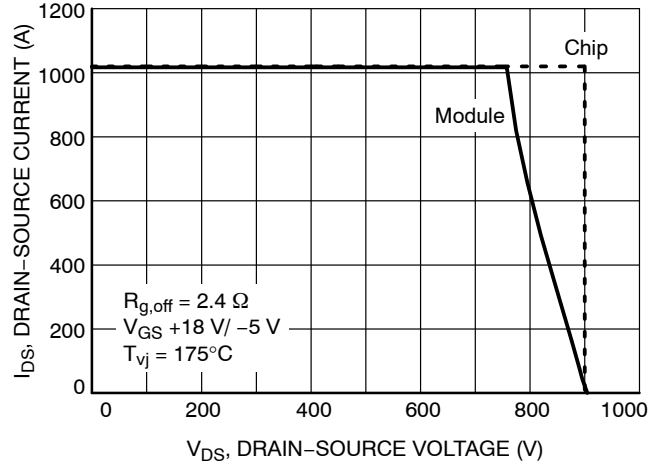

Figure 21. MOSFET RBSOA of Chip and Module

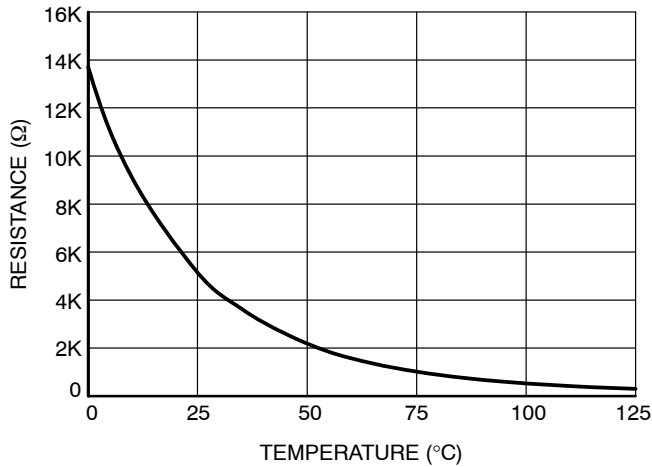

Figure 22. NTC Resistance vs. Temperature

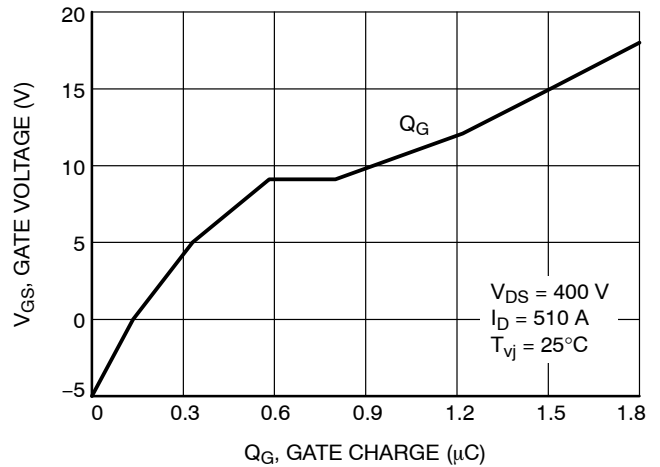
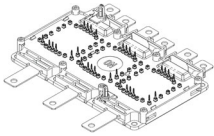

Figure 23. Gate Charge vs. Gate-Source Voltage

MECHANICAL CASE OUTLINE

PACKAGE DIMENSIONS



SSDC39, 154.50x92.00
CASE 183AL
ISSUE C

DATE 16 AUG 2023

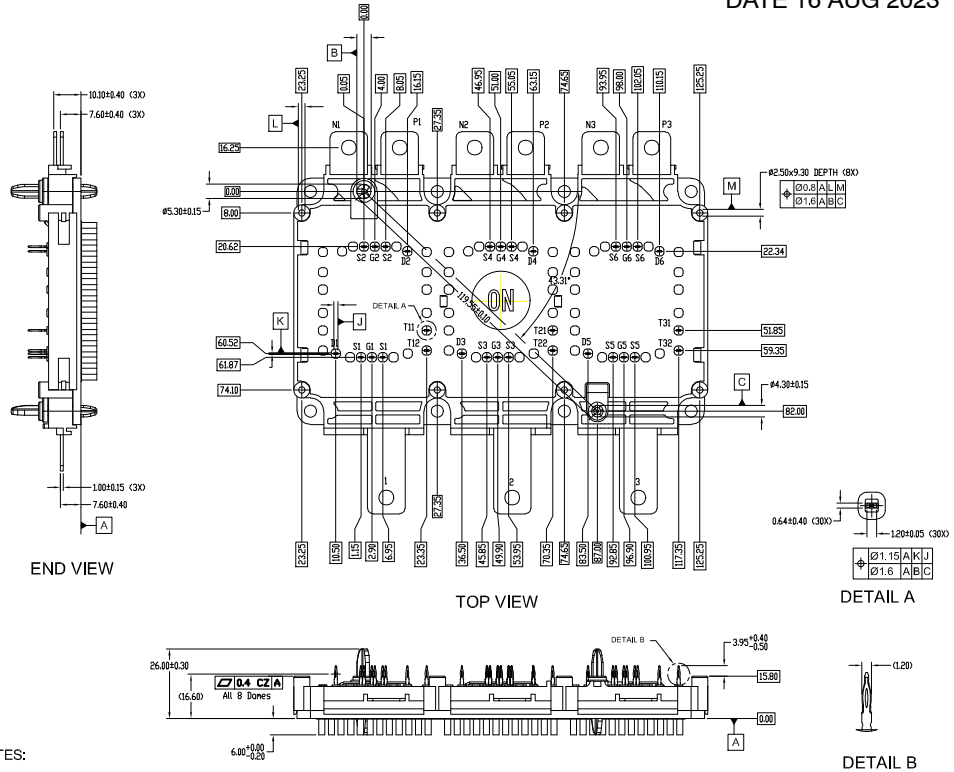

NOTES:

1. DIMENSIONING AND TOLERANCING PER ASME Y14.5M, 2009.
2. CONTROLLING DIMENSION: MILLIMETERS
3. SPC

GENERIC MARKING DIAGRAM*

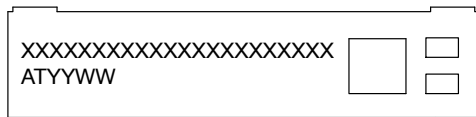

FRONTSIDE MARKING

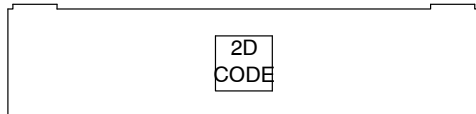

BACKSIDE MARKING

XXXXX = Specific Device Code
 AT = Assembly & Test Site Code
 YYWW = Year and Work Week Code

*This information is generic. Please refer to device data sheet for actual part marking. Pb-Free indicator, "G" or microdot "▪", may or may not be present. Some products may not follow the Generic Marking.

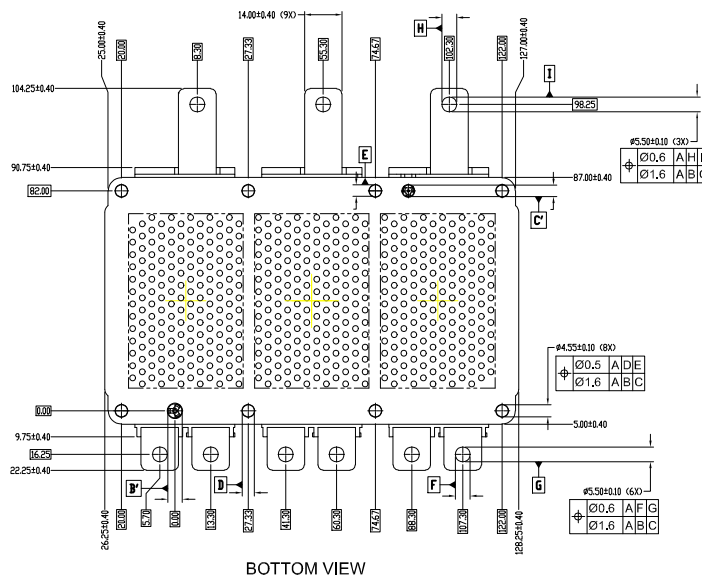

BOTTOM VIEW

DOCUMENT NUMBER:	98AON34291H	Electronic versions are uncontrolled except when accessed directly from the Document Repository. Printed versions are uncontrolled except when stamped "CONTROLLED COPY" in red.
DESCRIPTION:	SSDC39, 154.50x92.00	PAGE 1 OF 1

onsemi and ONSEMI are trademarks of Semiconductor Components Industries, LLC dba onsemi or its subsidiaries in the United States and/or other countries. onsemi reserves the right to make changes without further notice to any products herein. onsemi makes no warranty, representation or guarantee regarding the suitability of its products for any particular purpose, nor does onsemi assume any liability arising out of the application or use of any product or circuit, and specifically disclaims any and all liability, including without limitation special, consequential or incidental damages. onsemi does not convey any license under its patent rights nor the rights of others.

onsemi, **Onsemi**, and other names, marks, and brands are registered and/or common law trademarks of Semiconductor Components Industries, LLC dba "**onsemi**" or its affiliates and/or subsidiaries in the United States and/or other countries. **onsemi** owns the rights to a number of patents, trademarks, copyrights, trade secrets, and other intellectual property. A listing of **onsemi**'s product/patent coverage may be accessed at www.onsemi.com/site/pdf/Patent-Marking.pdf. **onsemi** reserves the right to make changes at any time to any products or information herein, without notice. The information herein is provided "as-is" and **onsemi** makes no warranty, representation or guarantee regarding the accuracy of the information, product features, availability, functionality, or suitability of its products for any particular purpose, nor does **onsemi** assume any liability arising out of the application or use of any product or circuit, and specifically disclaims any and all liability, including without limitation special, consequential or incidental damages. Buyer is responsible for its products and applications using **onsemi** products, including compliance with all laws, regulations and safety requirements or standards, regardless of any support or applications information provided by **onsemi**. "Typical" parameters which may be provided in **onsemi** data sheets and/or specifications can and do vary in different applications and actual performance may vary over time. All operating parameters, including "Typicals" must be validated for each customer application by customer's technical experts. **onsemi** does not convey any license under any of its intellectual property rights nor the rights of others. **onsemi** products are not designed, intended, or authorized for use as a critical component in life support systems or any FDA Class 3 medical devices or medical devices with a same or similar classification in a foreign jurisdiction or any devices intended for implantation in the human body. Should Buyer purchase or use **onsemi** products for any such unintended or unauthorized application, Buyer shall indemnify and hold **onsemi** and its officers, employees, subsidiaries, affiliates, and distributors harmless against all claims, costs, damages, and expenses, and reasonable attorney fees arising out of, directly or indirectly, any claim of personal injury or death associated with such unintended or unauthorized use, even if such claim alleges that **onsemi** was negligent regarding the design or manufacture of the part. **onsemi** is an Equal Opportunity/Affirmative Action Employer. This literature is subject to all applicable copyright laws and is not for resale in any manner.

ADDITIONAL INFORMATION

TECHNICAL PUBLICATIONS:

Technical Library: www.onsemi.com/design/resources/technical-documentation
onsemi Website: www.onsemi.com

ONLINE SUPPORT: www.onsemi.com/support

For additional information, please contact your local Sales Representative at www.onsemi.com/support/sales