

FTCO3V455A2

3-Phase Inverter Automotive Power Module

General Description

The FTCO3V455A2 is a 40 V low $R_{ds(on)}$ automotive qualified power module featuring a 3-phase MOSFET inverter optimized for 12 V battery systems. It includes a precision shunt resistor for current sensing an NTC for temperature sensing and an RC snubber circuit.

The module utilizes ON Semiconductor's trench MOSFET technology and it is designed to provide a very compact and high performance variable speed motor drive for applications like electric power steering, electro-hydraulic power steering, electric water pumps, electric oil pumps. The power module is 100% lead free, RoHS and UL compliant.

Features

- 40 V – 150 A 3-phase Trench MOSFET Inverter Bridge
- 1% Precision Shunt Current Sensing
- Temperature Sensing
- DBC Substrate
- 100% Lead Free and RoHS Compliant 2000/53/C Directive
- UL94V-0 Compliant
- Isolation Rating of 2500 V rms/min
- Mounting Through Screws
- Automotive Qualified

Benefits

- Low Junction-sink Thermal Resistance
- Low Inverter Electrical Resistance
- High Current Handling
- Compact Motor Design
- Highly Integrated Compact Design
- Better EMC and Electrical Isolation
- Easy and Reliable Installation
- Improved Overall System Reliability

Applications

- Electric and Electro-Hydraulic Power Steering
- Electric Water Pump
- Electric Oil Pump
- Electric Fan

Flammability Information

- All Materials Present in the Power Module Meet UL Flammability Rating Class 94 V-0 or Higher.

Solder

- Solder Used is a Lead Free SnAgCu Alloy.



ON Semiconductor®

www.onsemi.com

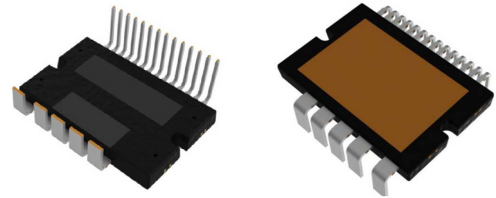

MOD-19
CASE MODCC

ELECTRICAL CONNECTION

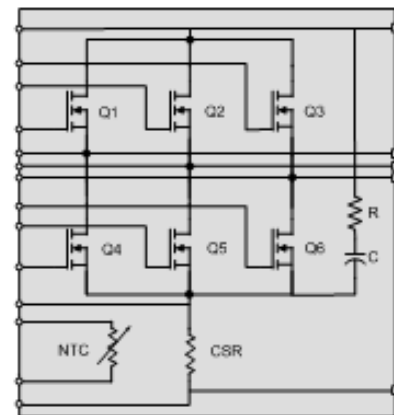

MARKING DIAGRAM

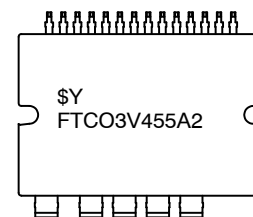

\$Y = ON Semiconductor
FTCO3V455A2 = Specific Device Code

ORDERING INFORMATION

See detailed ordering and shipping information on page 8 of this data sheet.

FTCO3V455A2

MAXIMUM RATINGS (T_J = 25°C, Unless Otherwise Specified)

Symbol	Parameter	Rating	Unit
V _{DS} (Q1~Q6)	Drain to Source Voltage	40	V
V _{GS} (Q1~Q6)	Gate to Source Voltage	±20	V
I _D (Q1~Q6)	Drain Current Continuous(T _C = 25°C, V _{GS} = 10V) (Note 1)	150	A
E _{AS} (Q1~Q6)	Single Pulse Avalanche Energy (Note 2)	947	mJ
P _D	Power dissipation	115	W
T _J	Maximum Junction Temperature	175	°C
T _{STG}	Storage Temperature	125	°C

Stresses exceeding those listed in the Maximum Ratings table may damage the device. If any of these limits are exceeded, device functionality should not be assumed, damage may occur and reliability may be affected.

THERMAL RESISTANCE

Symbol	Parameter	Min.	Typ.	Max.	Unit
R _{thjc} Thermal Resis- tance Junction to case, Single Inverter FET, PKG center (Note 3)	Q1 Thermal Resistance J –C	–	1.3	1.7	°C/W
	Q2 Thermal Resistance J –C	–	1.3	1.7	°C/W
	Q3 Thermal Resistance J –C	–	1.3	1.7	°C/W
	Q4 Thermal Resistance J –C	–	1.2	1.6	°C/W
	Q5 Thermal Resistance J –C	–	1.2	1.6	°C/W
	Q6 Thermal Resistance J –C	–	1.2	1.6	°C/W
T _J	Maximum Junction Temperature	–		175	°C
T _S	Operating Sink Temperature	–40		120	°C
T _{STG}	Storage Temperature	–40		125	°C

1. Max value to not exceed T_J = 175°C based on R_{thjc} thermal limitation. Defined by design, not subject to production testing.
2. Starting T_J = 25°C, V_{ds} = 20 V, I_{as} = 64 A, L = 480 μH.
3. These values are based on Thermal simulations and PV level measurements.
These values assume a single MOSFET is on, and the test condition for referenced temperature is “Package Center”.
This means that the DT is measured between the T_J of each MOSFET and the bottom surface temperature immediately under the thermal media in the center of the package.

FTCO3V455A2

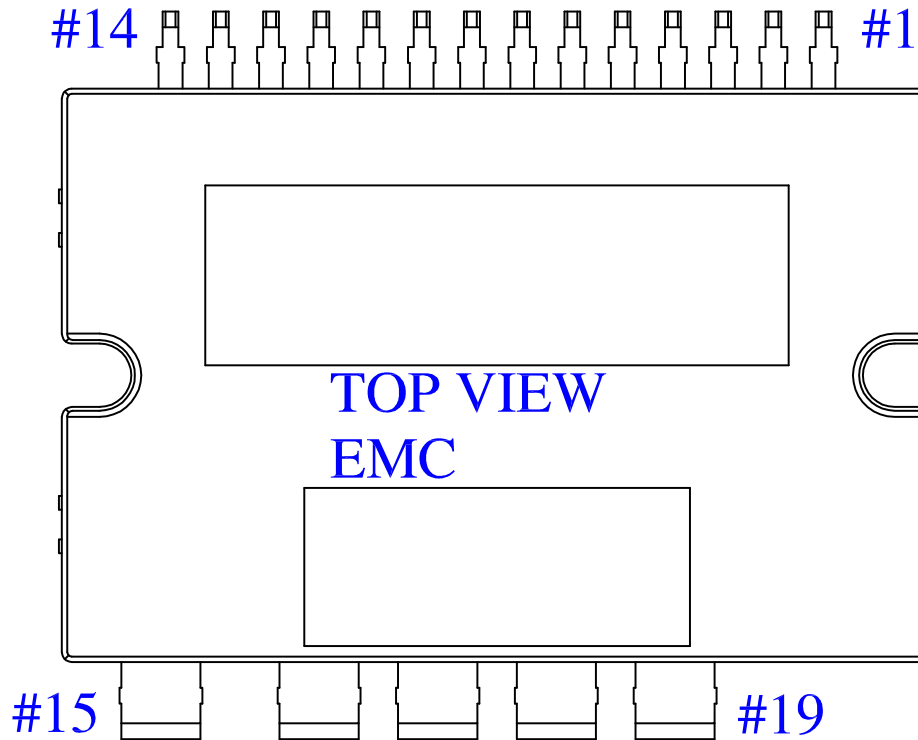

Figure 1. Pin Configuration

PIN DESCRIPTION

Pin Number	Pin Name	Pin Descriptions
1	TEMP 1	NTC Thermistor Terminal 1
2	TEMP 2	NTC Thermistor Terminal 2
3	PHASE W SENSE	Source of HS W and Drain of LS W
4	GATE HS W	Gate of HS phase W MOSFET
5	GATE LS W	Gate of LS phase W MOSFET
6	PHASE V SENSE	Source of HS V and Drain of LS V
7	GATE HS V	Gate of HS phase V MOSFET
8	GATE LS V	Gate of LS phase V MOSFET
9	PHASE U SENSE	Source of HS U and Drain of LS U
10	GATE HS U	Gate of HS phase U MOSFET
11	VBAT SENSE	Drain of HS U, V and W MOSFET
12	GATE LS U	Gate of LS phase U MOSFET
13	SHUNT P	Source of LS U, V W MOSFETS / Shunt +
14	SHUNT N	Negative shunt terminal (shunt -)
15	VBAT	Positive battery terminal
16	GND	Negative battery terminal
17	PHASE U	Motor phase U
18	PHASE V	Motor phase V
19	PHASE W	Motor phase W

FTCO3V455A2

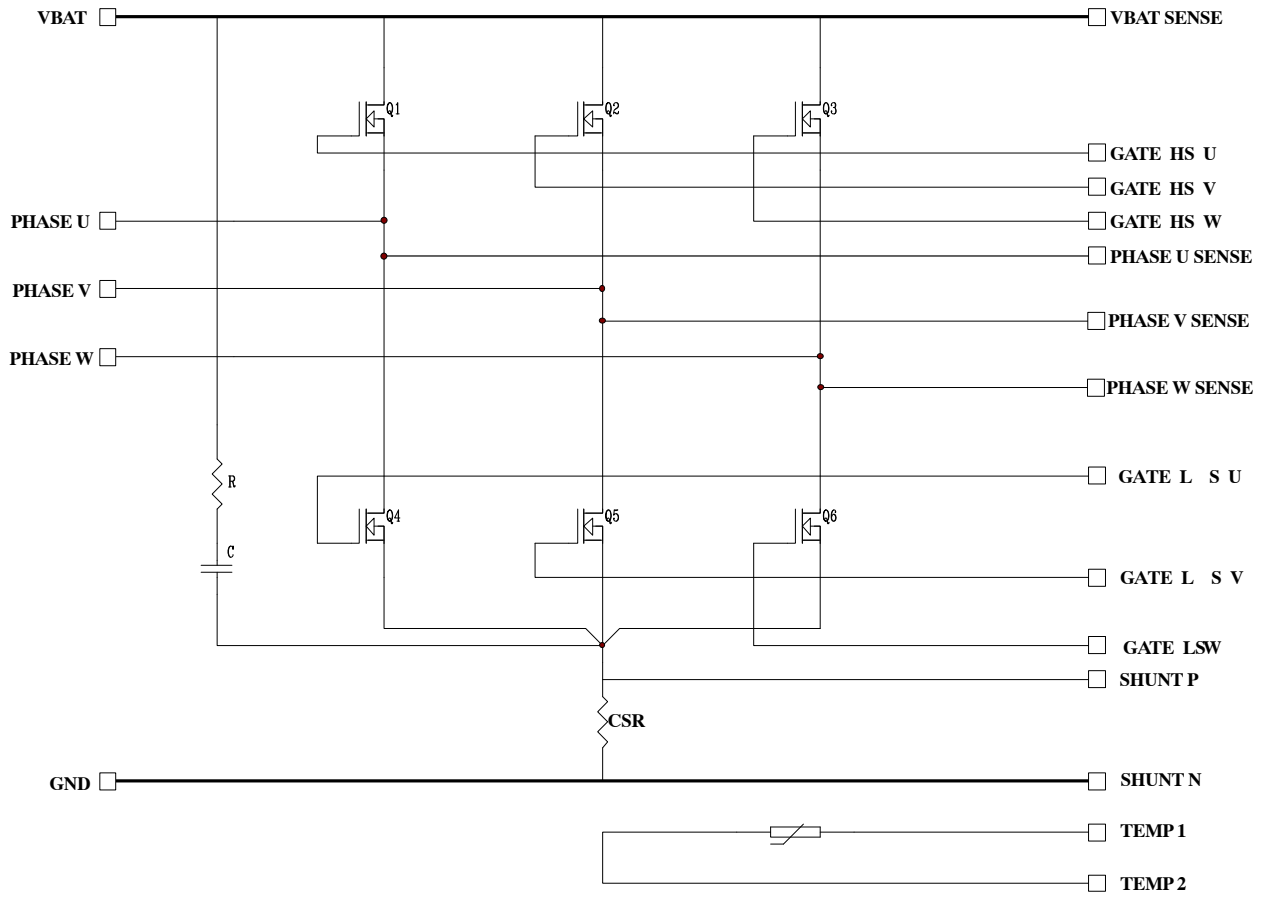

Figure 2. Internal Equivalent Circuit

FTCO3V455A2

ELECTRICAL CHARACTERISTICS (T_J = 25 °C, Unless Otherwise Specified)

Symbol	Parameter	Test Condition	Min	Typ	Max	Unit
BV _{DSS}	D-S Breakdown Voltage (Inverter MOSFETs)	V _{GS} =0, I _D =250uA	40	-	-	V
V _{GS}	Gate to Source Voltage (Inverter MOSFETs)		-20	-	20	V
V _{TH}	Threshold Voltage (Inverter MOSFETs)	V _{GS} =V _{DS} , I _D =250uA, T _J =25 °C	2.0	2.8	4.0	V
V _{SD}	MOSFET Body Diode Forward Voltage	V _{GS} =0V, I _S =80A, T _J =25 °C		0.8	1.28	V
R _{DS(ON)Q1}	Inverter High Side MOSFETs Q1 (See Note 4)	V _{GS} =10V, I _D =80A, T _J =25 °C	-	1.15	1.66	mΩ
R _{DS(ON)Q2}	Inverter High Side MOSFETs Q2 (See Note 4)	V _{GS} =10V, I _D =80A, T _J =25 °C	-	1.22	1.73	mΩ
R _{DS(ON)Q3}	Inverter High Side MOSFETs Q3 (See Note 4)	V _{GS} =10V, I _D =80A, T _J =25 °C	-	1.31	1.82	mΩ
R _{DS(ON)Q4}	Inverter Low Side MOSFETs Q4 (See Note 4)	V _{GS} =10V, I _D =80A, T _J =25 °C	-	1.36	1.87	mΩ
R _{DS(ON)Q5}	Inverter Low Side MOSFETs Q5 (See Note 4)	V _{GS} =10V, I _D =80A, T _J =25 °C	-	1.57	2.08	mΩ
R _{DS(ON)Q6}	Inverter Low Side MOSFETs Q6 (See Note 4)	V _{GS} =10V, I _D =80A, T _J =25 °C	-	1.86	2.32	mΩ
I _{DSS}	Inverter MOSFETs (UH,UL,VH,VL,WH,WL)	V _{GS} =0V, V _{DS} =32V, T _J =25 °C	-	-	1.0	μA
I _{GSS}	Inverter MOSFETs Gate to Source Leakage Current	V _{GS} =±20V	-	-	±100	nA
Total loop resistance VLINK(+) - V0 (-)		V _{GS} =10V, I _D =80A, T _J =25 °C	-	4.69	5.5	mΩ

DYNAMIC CHARACTERISTICS

C _{iss}	Input Capacitance	V _{DS} = 25 V, V _{GS} = 0 V, f = 1 MHz	-	15000	-	pF
C _{oss}	Output Capacitance		-	1250	-	pF
C _{rss}	Reverse Transfer Capacitance		-	685	-	pF
R _G	Gate Resistance	V _{GS} = 0.5 V, f = 1 MHz	-	1.1	-	Ω
Q _{g(TOT)}	Total Gate Charge at 10 V	V _{GS} = 0 to 10 V, V _{DD} = 20 V, I _D = 35 A, I _g = 1 mA	-	215	280	nC
Q _{g(TH)}	Threshold Gate Charge	V _{GS} = 0 to 2 V, V _{DD} = 20 V, I _D = 35 A, I _g = 1 mA	-	29	38	nC
Q _{gs}	Gate to Source Gate Charge	V _{DD} = 20 V, I _D = 35 A, I _g = 1 mA	-	60	-	nC
Q _{gs2}	Gate Charge Threshold to Plateau		-	32	-	nC
Q _{gd}	Gate to Drain "Miller" Charge		-	49	-	nC

TEMPERATURE SENSE (NTC Thermistor)

Symbol	Test Conditions	Test Time	Min	Typ	Max	Unit
Voltage	Current = 1 mA, Temperature = 25 °C	T = 0.5 ms	7.5	-	12	V

CURRENT SENSE RESISTOR

Symbol	Test Conditions	Test Time	Min	Typ	Max	Unit
Resistance	Current Sense resistor current = 80 A	T = 0.5 ms	0.46	-	0.53	mΩ

TYPICAL CHARACTERISTICS

(Generated using MOSFETs assembled in a TO263 package, for reference purposes only.)

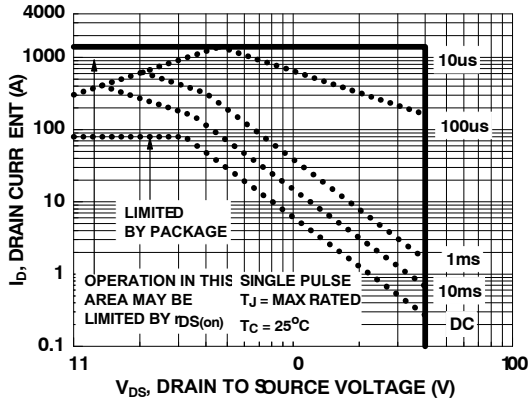
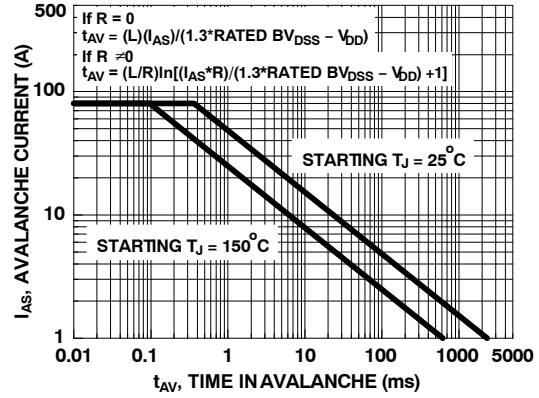

Figure 3. Forward Bias Safe Operating Area



NOTE: Refer to Fairchild Application Notes AN7514 and AN7515

Figure 4. Unclamped Inductive Switching Capability

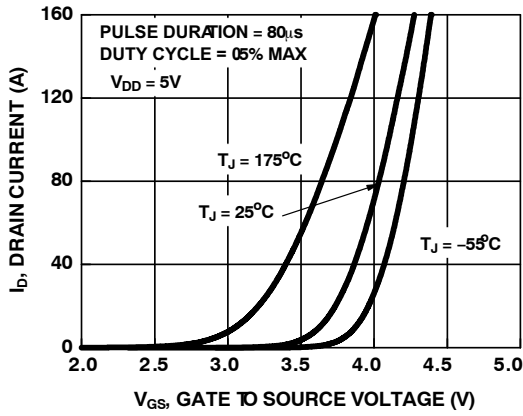

Figure 5. Transfer Characteristics

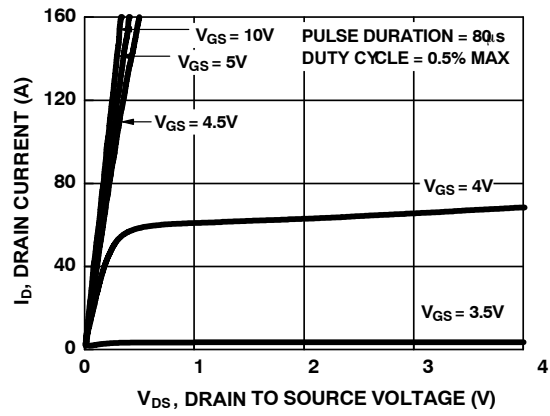

Figure 6. Saturation Characteristics

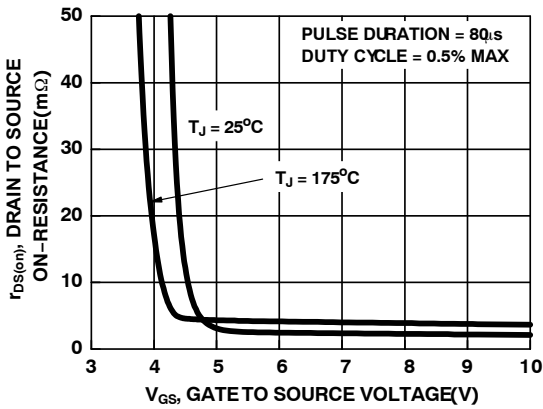

Figure 7. Drain to Source On-Resistance Variation vs Gate to Source Voltage

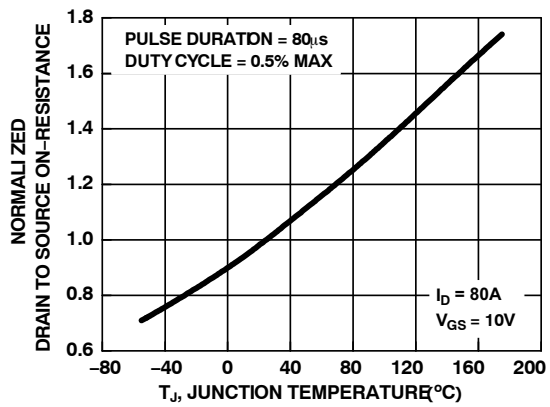

Figure 8. Normalized Drain to Source On Resistance vs Junction Temperature

FTCO3V455A2

TYPICAL CHARACTERISTICS

(Generated using MOSFETs assembled in a TO263 package, for reference purposes only.)

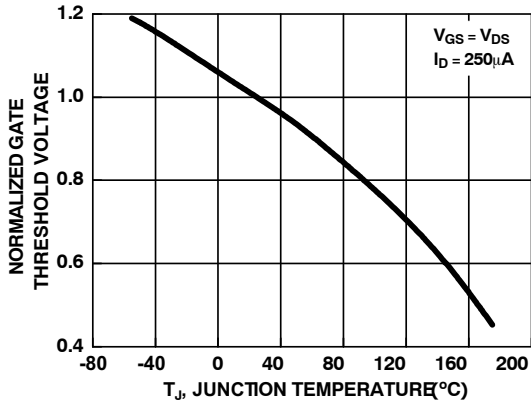

Figure 9. Normalized Gate Threshold Voltage vs Junction Temperature

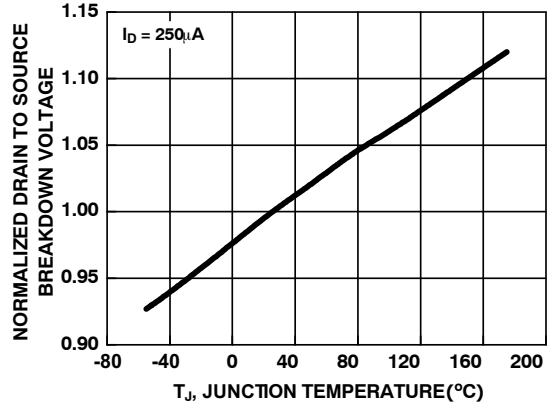

Figure 10. Normalized Drain to Source Breakdown Voltage vs Junction Temperature

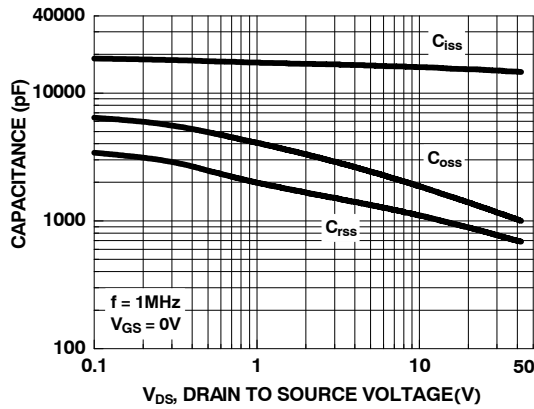

Figure 11. Capacitance vs Drain to Source Voltage

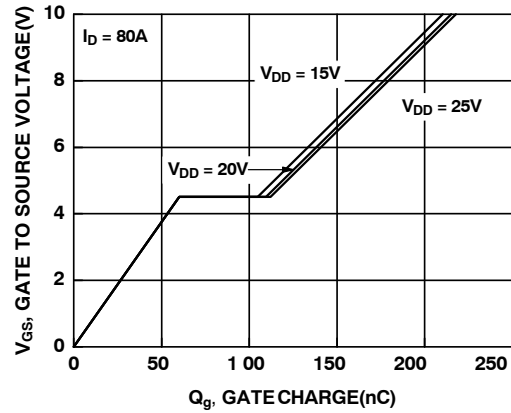
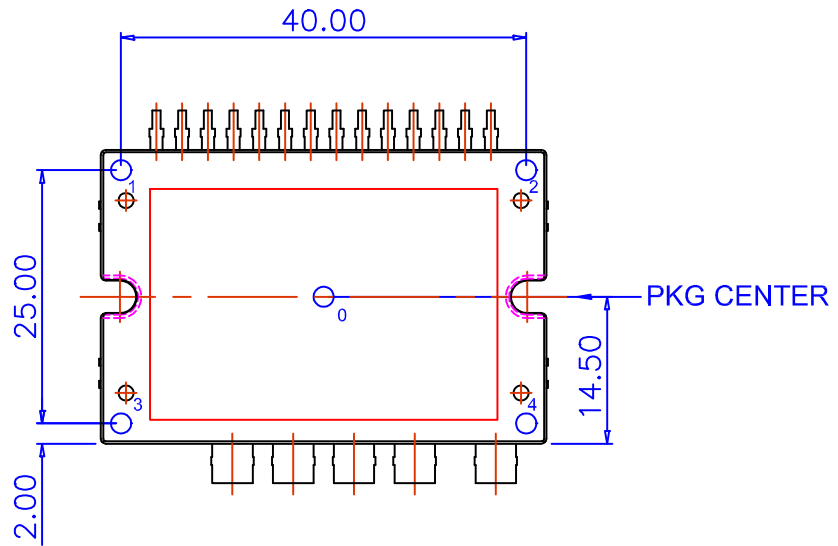

Figure 12. Gate Charge vs Gate to Source Voltage

MECHANICAL CHARACTERISTICS AND RATINGS

Parameter	Condition	Limits			Unit
		Min	Typ	Max	
Device Flatness	Note Fig. 15	0	-	+150	µm
Mounting Torque	Mounting Screw: - M3, Recommended 0.7 N.m	0.6	0.7	0.8	N.m
Weight		-	20	-	g

FTCO3V455A2



FLATNESS : MAX. 150um

-. MEASURING AT INDICATING POINTS
1, 2, 3, AND 4 (BASED ON "0")

ORDERING INFORMATION

Device Marking	Packing Type	Quantity
FTCO3V455A2	Tube	11

MECHANICAL CASE OUTLINE PACKAGE DIMENSIONS

ON Semiconductor®



19LD APM PDD STD CASE MODCC ISSUE O

DATE 30 NOV 2016

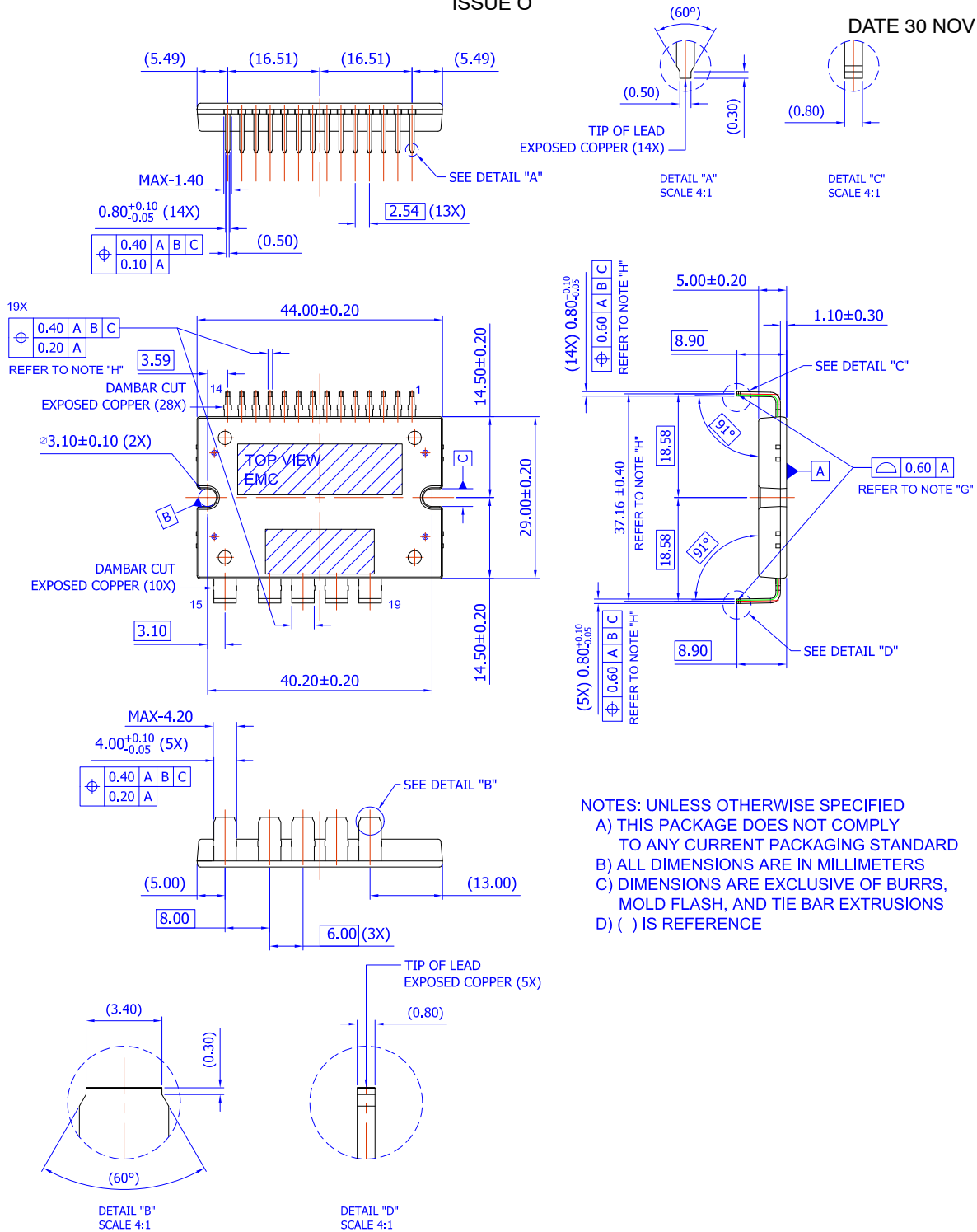

NOTES: UNLESS OTHERWISE SPECIFIED
 A) THIS PACKAGE DOES NOT COMPLY TO ANY CURRENT PACKAGING STANDARD
 B) ALL DIMENSIONS ARE IN MILLIMETERS
 C) DIMENSIONS ARE EXCLUSIVE OF BURRS, MOLD FLASH, AND TIE BAR EXTRUSIONS
 D) () IS REFERENCE

DOCUMENT NUMBER:	98AON13504G	Electronic versions are uncontrolled except when accessed directly from the Document Repository. Printed versions are uncontrolled except when stamped "CONTROLLED COPY" in red.
DESCRIPTION:	19LD APM PDD STD	PAGE 1 OF 1

ON Semiconductor and ON are trademarks of Semiconductor Components Industries, LLC dba ON Semiconductor or its subsidiaries in the United States and/or other countries. ON Semiconductor reserves the right to make changes without further notice to any products herein. ON Semiconductor makes no warranty, representation or guarantee regarding the suitability of its products for any particular purpose, nor does ON Semiconductor assume any liability arising out of the application or use of any product or circuit, and specifically disclaims any and all liability, including without limitation special, consequential or incidental damages. ON Semiconductor does not convey any license under its patent rights nor the rights of others.

onsemi, **Onsemi**, and other names, marks, and brands are registered and/or common law trademarks of Semiconductor Components Industries, LLC dba "**onsemi**" or its affiliates and/or subsidiaries in the United States and/or other countries. **onsemi** owns the rights to a number of patents, trademarks, copyrights, trade secrets, and other intellectual property. A listing of **onsemi**'s product/patent coverage may be accessed at www.onsemi.com/site/pdf/Patent-Marking.pdf. **onsemi** reserves the right to make changes at any time to any products or information herein, without notice. The information herein is provided "as-is" and **onsemi** makes no warranty, representation or guarantee regarding the accuracy of the information, product features, availability, functionality, or suitability of its products for any particular purpose, nor does **onsemi** assume any liability arising out of the application or use of any product or circuit, and specifically disclaims any and all liability, including without limitation special, consequential or incidental damages. Buyer is responsible for its products and applications using **onsemi** products, including compliance with all laws, regulations and safety requirements or standards, regardless of any support or applications information provided by **onsemi**. "Typical" parameters which may be provided in **onsemi** data sheets and/or specifications can and do vary in different applications and actual performance may vary over time. All operating parameters, including "Typicals" must be validated for each customer application by customer's technical experts. **onsemi** does not convey any license under any of its intellectual property rights nor the rights of others. **onsemi** products are not designed, intended, or authorized for use as a critical component in life support systems or any FDA Class 3 medical devices or medical devices with a same or similar classification in a foreign jurisdiction or any devices intended for implantation in the human body. Should Buyer purchase or use **onsemi** products for any such unintended or unauthorized application, Buyer shall indemnify and hold **onsemi** and its officers, employees, subsidiaries, affiliates, and distributors harmless against all claims, costs, damages, and expenses, and reasonable attorney fees arising out of, directly or indirectly, any claim of personal injury or death associated with such unintended or unauthorized use, even if such claim alleges that **onsemi** was negligent regarding the design or manufacture of the part. **onsemi** is an Equal Opportunity/Affirmative Action Employer. This literature is subject to all applicable copyright laws and is not for resale in any manner.

ADDITIONAL INFORMATION

TECHNICAL PUBLICATIONS:

Technical Library: www.onsemi.com/design/resources/technical-documentation
onsemi Website: www.onsemi.com

ONLINE SUPPORT: www.onsemi.com/support

For additional information, please contact your local Sales Representative at www.onsemi.com/support/sales