

MOSFET – Power, N-Channel, Dual ECH8

30 V, 8 A, 20.5 mΩ

ECH8663R

特長

- 低オン抵抗
- 2.5 V 駆動
- コモンドレインタイプ
- 保護ダイオード入り
- ゲート保護用抵抗内蔵
- Lib 充放電スイッチ用途に最適
- ハロゲンフリー対応

絶対最大定格 ABSOLUTE MAXIMUM RATINGS (Ta = 25°C)

項目	記号	条件	定格値	Unit
ドレイン・ソース電圧	V _{DSS}		30	V
ゲート・ソース電圧	V _{GSS}		±12	V
ドレイン電流 (DC)	I _D		8	A
ドレイン電流 (パルス)	I _{DP}	PW ≤ 10 μs, duty cycle ≤ 1%	60	A
許容損失	P _D	セラミック基板 (900 mm ² × 0.8 mm) 装着時 1 unit	1.4	W
全損失	P _T	セラミック基板 (900 mm ² × 0.8 mm) 装着時	1.5	W
チャネル温度	T _{ch}		150	°C
保存周囲温度	T _{stg}		-55~+150	°C

Stresses exceeding those listed in the Maximum Ratings table may damage the device. If any of these limits are exceeded, device functionality should not be assumed, damage may occur and reliability may be affected.

(参考訳)

最大定格を超えるストレスは、デバイスにダメージを与える危険性があります。これらの定格値を超えた場合は、デバイスの機能性を損ない、ダメージが生じ、信頼性に影響を及ぼす危険性があります。

V _{DSS}	R _{Ds(on)} MAX	I _D MAX
30 V	20.5 mΩ @ 4.5 V	8 A
	21 mΩ @ 4.0 V	
	23 mΩ @ 3.1 V	
	28 mΩ @ 2.5 V	

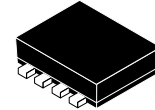

SOT-28FL / ECH8
CASE 318BF

マーキング

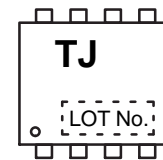

電気的接続図

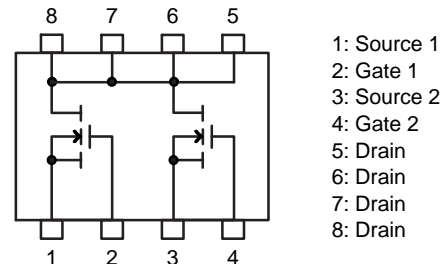

ORDERING INFORMATION

Device	パッケージ名	Shipping†
ECH8663R-TL-H	SOT-28FL / ECH8 (Pb-Free and Halide Free)	3000 / Tape & Reel

†For information on tape and reel specifications, including part orientation and tape sizes, please refer to our Tape and Reel Packaging Specifications Brochure, BRD8011/D.

ECH8663R

電気的特性 ELECTRICAL CHARACTERISTICS (Ta = 25°C)

項目	記号	条件	定格値			Unit
			Min	Typ	Max	
ドレイン・ソース降伏電圧	$V_{(BR)DSS}$	$I_D = 1 \text{ mA}, V_{GS} = 0 \text{ V}$	30	-	-	V
ドレイン・ソースシャ断電流	I_{DSS}	$V_{DS} = 30 \text{ V}, V_{GS} = 0 \text{ V}$	-	-	1	μA
ゲート・ソースもれ電流	I_{GSS}	$V_{GS} = \pm 8 \text{ V}, V_{DS} = 0 \text{ V}$	-	-	± 10	μA
ゲート・ソースシャ断電圧	$V_{GS(off)}$	$V_{DS} = 10 \text{ V}, I_D = 1 \text{ mA}$	0.5	-	1.3	V
順伝達アドミタンス	$ y_{fs} $	$V_{DS} = 10 \text{ V}, I_D = 4 \text{ A}$	5	8.5	-	S
ドレイン・ソース間オン抵抗	$R_{DS(on)1}$	$I_D = 4 \text{ A}, V_{GS} = 4.5 \text{ V}$	10.5	15.5	20.5	$\text{m}\Omega$
	$R_{DS(on)2}$	$I_D = 4 \text{ A}, V_{GS} = 4.0 \text{ V}$	11	16	21	$\text{m}\Omega$
	$R_{DS(on)3}$	$I_D = 2 \text{ A}, V_{GS} = 3.1 \text{ V}$	12	17.5	23	$\text{m}\Omega$
	$R_{DS(on)4}$	$I_D = 2 \text{ A}, V_{GS} = 2.5 \text{ V}$	12	20	28	$\text{m}\Omega$
ターンオン遅延時間	$t_d(on)$	指定回路において	-	320	-	ns
立ち上がり時間	t_r		-	850	-	ns
ターンオフ遅延時間	$t_d(off)$		-	4200	-	ns
下降時間	t_f		-	1800	-	ns
総ゲート電荷量	Q_g	$V_{DS} = 10 \text{ V}, V_{GS} = 4.5 \text{ V}, I_D = 8 \text{ A}$	-	12.3	-	nC
ゲート・ソース電荷量	Q_{gs}		-	2.4	-	nC
ゲート・ドレイン電荷量	Q_{gd}		-	2.8	-	nC
ダイオード順電圧	V_{SD}	$I_S = 8 \text{ A}, V_{GS} = 0 \text{ V}$	-	0.75	1.2	V

Product parametric performance is indicated in the Electrical Characteristics for the listed test conditions, unless otherwise noted. Product performance may not be indicated by the Electrical Characteristics if operated under different conditions.

(参考訳)

製品パラメータは、特別な記述が無い限り、記載されたテスト条件に対する電気的特性で示しています。異なる条件下で製品動作を行った時には、電気的特性で示している特性を得られない場合があります。

スイッチングタイム測定回路図



図 1. スwitchingタイム測定回路図

ECH8663R



ECH8663R

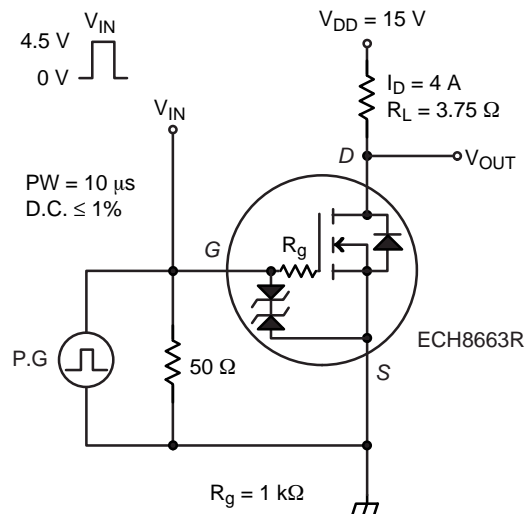
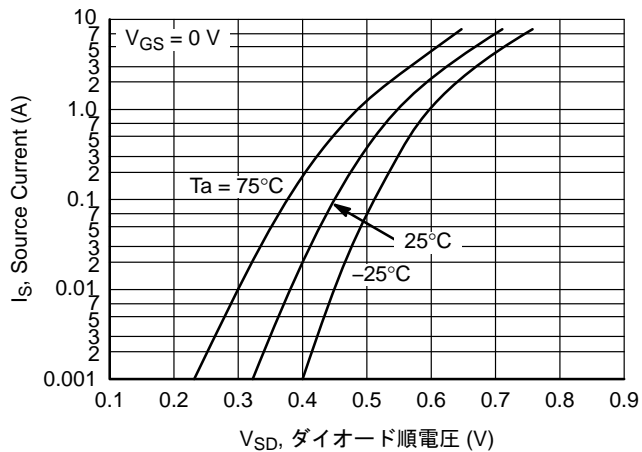
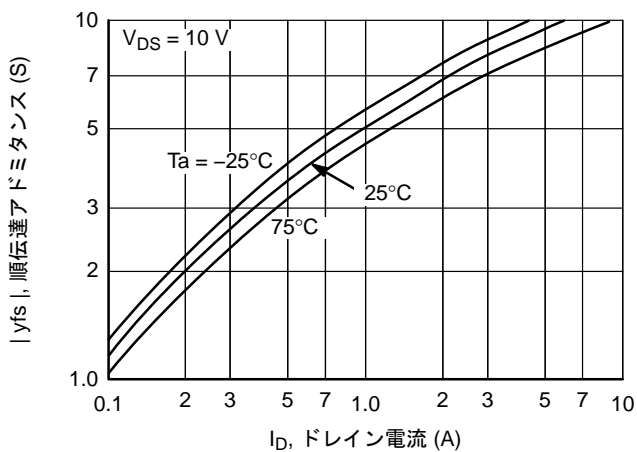
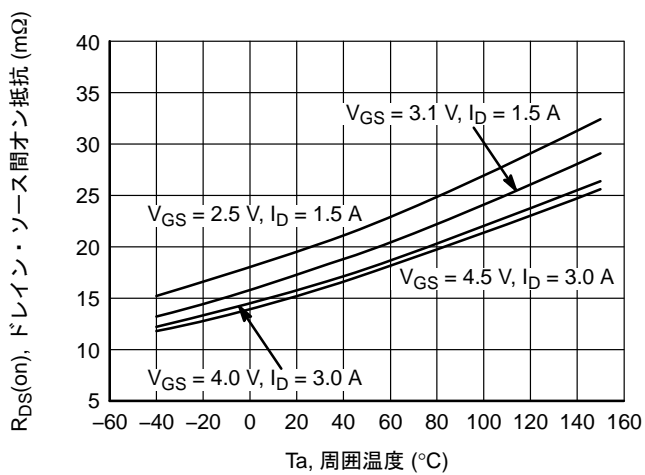
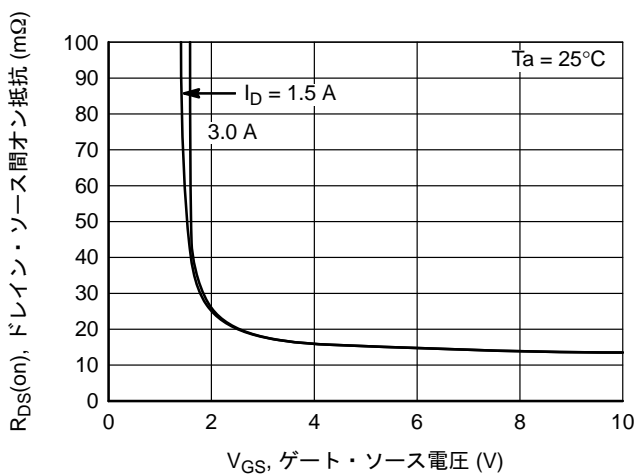
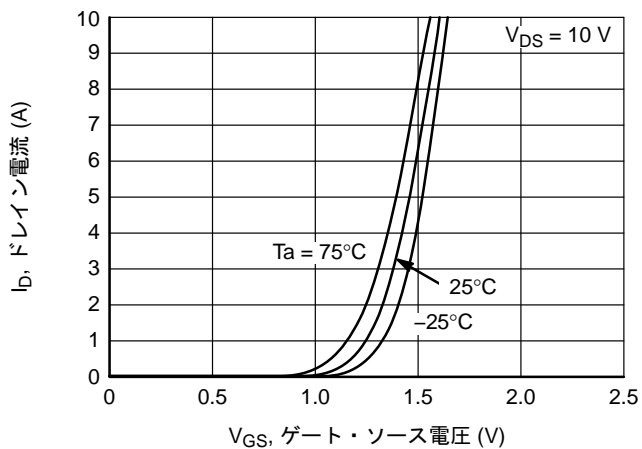
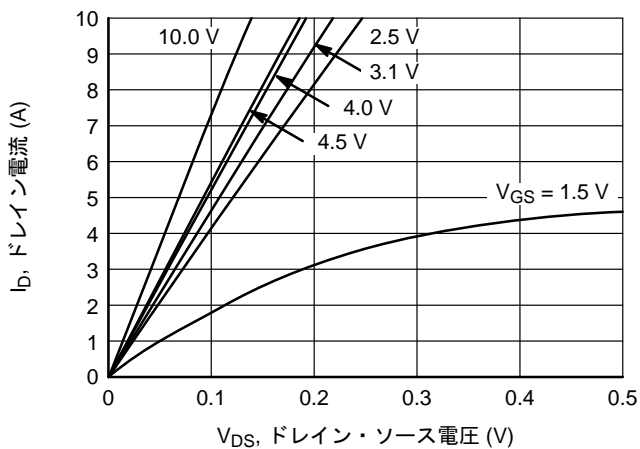
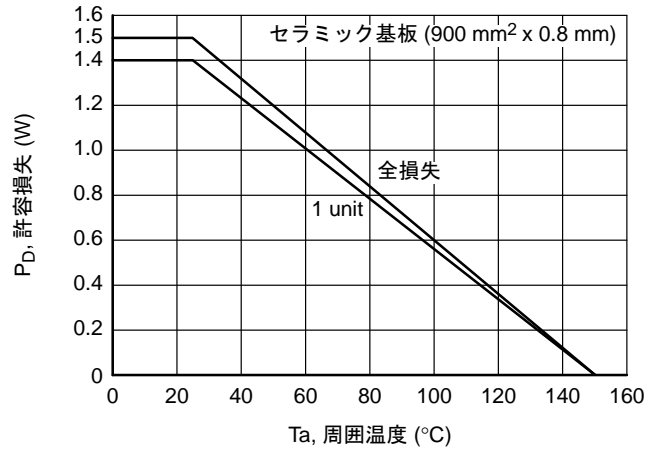
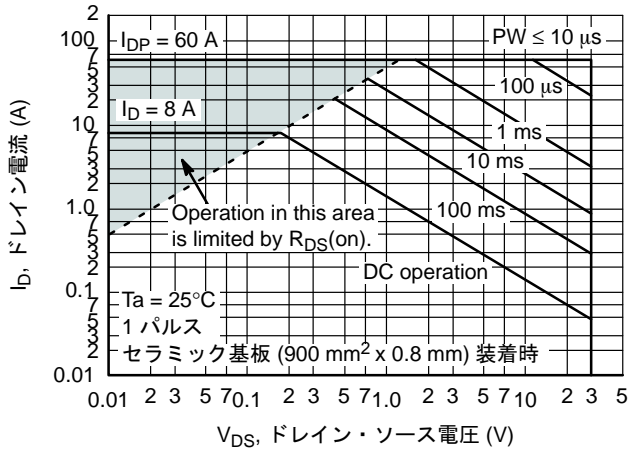
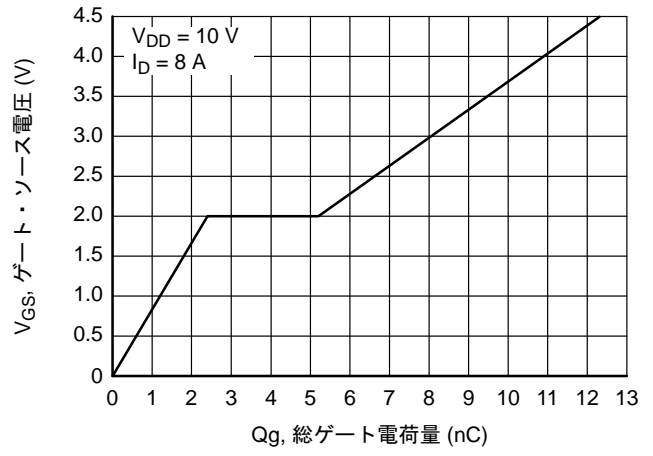
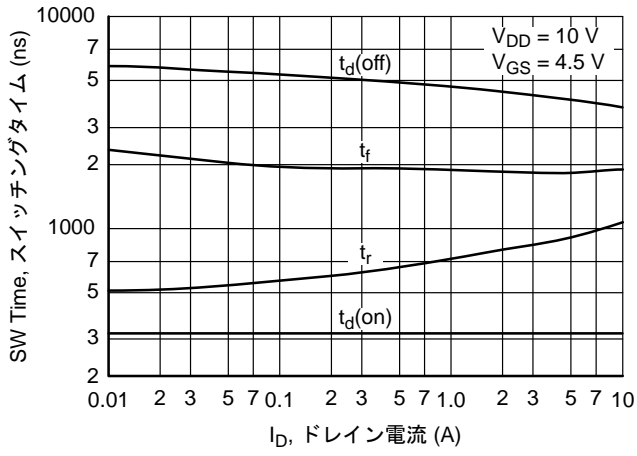

MECHANICAL CASE OUTLINE
PACKAGE DIMENSIONS

SOT-28FL / ECH8
CASE 318BF
ISSUE O

DATE 31 MAR 2012

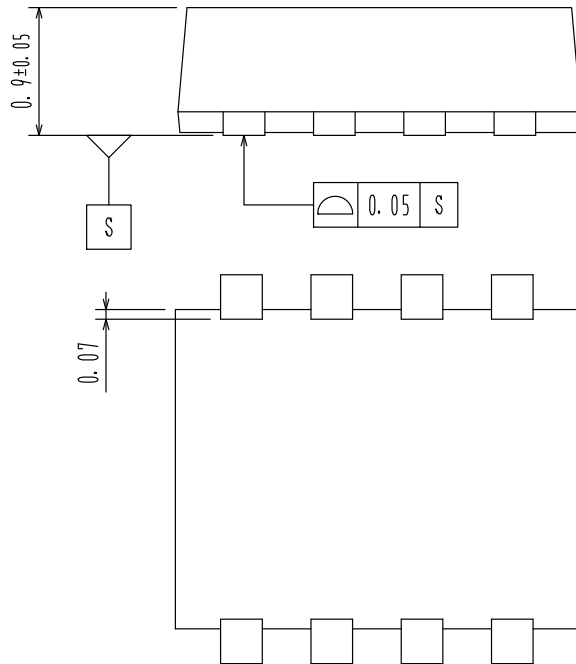
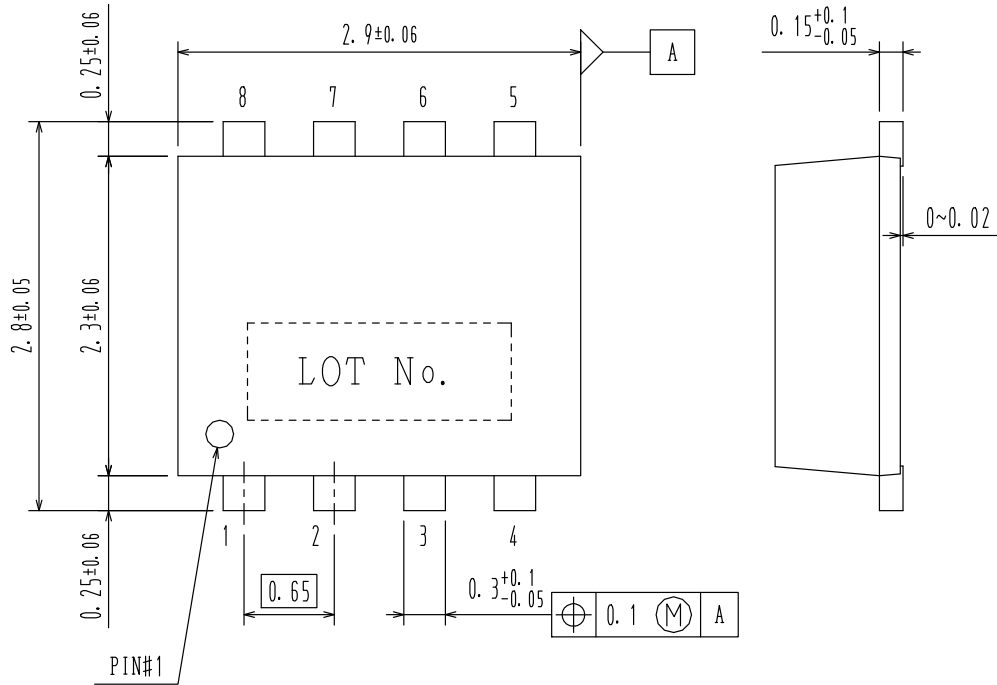

DOCUMENT NUMBER:	98AON78700E	Electronic versions are uncontrolled except when accessed directly from the Document Repository. Printed versions are uncontrolled except when stamped "CONTROLLED COPY" in red.
DESCRIPTION:	SOT-28FL / ECH8	PAGE 1 OF 1

ON Semiconductor and are trademarks of Semiconductor Components Industries, LLC dba ON Semiconductor or its subsidiaries in the United States and/or other countries. ON Semiconductor reserves the right to make changes without further notice to any products herein. ON Semiconductor makes no warranty, representation or guarantee regarding the suitability of its products for any particular purpose, nor does ON Semiconductor assume any liability arising out of the application or use of any product or circuit, and specifically disclaims any and all liability, including without limitation special, consequential or incidental damages. ON Semiconductor does not convey any license under its patent rights nor the rights of others.

onsemi, **Onsemi**, and other names, marks, and brands are registered and/or common law trademarks of Semiconductor Components Industries, LLC dba "**onsemi**" or its affiliates and/or subsidiaries in the United States and/or other countries. **onsemi** owns the rights to a number of patents, trademarks, copyrights, trade secrets, and other intellectual property. A listing of **onsemi**'s product/patent coverage may be accessed at www.onsemi.com/site/pdf/Patent-Marking.pdf. **onsemi** reserves the right to make changes at any time to any products or information herein, without notice. The information herein is provided "as-is" and **onsemi** makes no warranty, representation or guarantee regarding the accuracy of the information, product features, availability, functionality, or suitability of its products for any particular purpose, nor does **onsemi** assume any liability arising out of the application or use of any product or circuit, and specifically disclaims any and all liability, including without limitation special, consequential or incidental damages. Buyer is responsible for its products and applications using **onsemi** products, including compliance with all laws, regulations and safety requirements or standards, regardless of any support or applications information provided by **onsemi**. "Typical" parameters which may be provided in **onsemi** data sheets and/or specifications can and do vary in different applications and actual performance may vary over time. All operating parameters, including "Typicals" must be validated for each customer application by customer's technical experts. **onsemi** does not convey any license under any of its intellectual property rights nor the rights of others. **onsemi** products are not designed, intended, or authorized for use as a critical component in life support systems or any FDA Class 3 medical devices or medical devices with a same or similar classification in a foreign jurisdiction or any devices intended for implantation in the human body. Should Buyer purchase or use **onsemi** products for any such unintended or unauthorized application, Buyer shall indemnify and hold **onsemi** and its officers, employees, subsidiaries, affiliates, and distributors harmless against all claims, costs, damages, and expenses, and reasonable attorney fees arising out of, directly or indirectly, any claim of personal injury or death associated with such unintended or unauthorized use, even if such claim alleges that **onsemi** was negligent regarding the design or manufacture of the part. **onsemi** is an Equal Opportunity/Affirmative Action Employer. This literature is subject to all applicable copyright laws and is not for resale in any manner.

ADDITIONAL INFORMATION

TECHNICAL PUBLICATIONS:

Technical Library: www.onsemi.com/design/resources/technical-documentation
onsemi Website: www.onsemi.com

ONLINE SUPPORT: www.onsemi.com/support

For additional information, please contact your local Sales Representative at www.onsemi.com/support/sales