

MMIC Amplifier

3 V, 16 mA, 0.1 to 3.6 GHz, MCPH6

SMA3109

特長

- 高利得である : $G_p = 23 \text{ dB Typ. @ } 1 \text{ GHz}$
- 動作周波数帯域が広い : $f_u = 3.6 \text{ GHz}$
- 低消費電流 : $I_{CC} = 16 \text{ mA Typ}$
- 高出力パワー : $P_o(1\text{dB}) = 4 \text{ dBm}$
- 特性インピーダンス : 入出力 50Ω
- This is a Pb-Free Device

絶対最大定格 ABSOLUTE MAXIMUM RATINGS ($T_a = 25^\circ\text{C}$)

記号	項目	定格値	Unit
V_{CC}	電源電圧	5	V
I_{CC}	回路電流	25	mA
P_D	許容損失	280	mW
T_{opr}	動作周囲温度	-40~ +85	$^\circ\text{C}$
T_{stg}	保存周囲温度	-55~ +150	$^\circ\text{C}$

Stresses exceeding those listed in the Maximum Ratings table may damage the device. If any of these limits are exceeded, device functionality should not be assumed, damage may occur and reliability may be affected.

(参考訳)

最大定格を超えるストレスは、デバイスにダメージを与える危険性があります。これらの定格値を超えた場合は、デバイスの機能性を損ない、ダメージが生じ、信頼性に影響を及ぼす危険性があります。

推奨動作範囲 ($T_a = 25^\circ\text{C}$)

記号	項目	定格値			Unit
		Min	Typ	Max	
V_{CC}	電源電圧	2.7	3	3.3	V
T_{opr}	動作周囲温度	-40	+25	+85	$^\circ\text{C}$

Functional operation above the stresses listed in the Recommended Operating Ranges is not implied. Extended exposure to stresses beyond the Recommended Operating Ranges limits may affect device reliability.

(参考訳)

推奨動作範囲を超えるストレスでは推奨動作機能を得られません。推奨動作範囲を超えるストレスの印加は、デバイスの信頼性に影響を与える危険性があります。

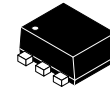

SC-88FL / MCPH6
CASE 419AS

マーキング

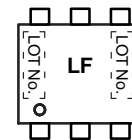

PIN DESCRIPTION

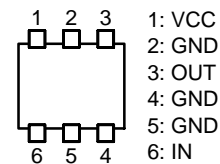

ORDERING INFORMATION

See detailed ordering and shipping information on page 5 of this data sheet.

SMA3109

電気的特性 ELECTRICAL CHARACTERISTICS ($T_a = 25^\circ\text{C}$, $V_{CC} = 3\text{ V}$, $Z_S = Z_L = 50\ \Omega$)

記号	項目	条件	定格値			Unit
			Min	Typ	Max	
I_{CC}	回路電流		11.5	16.0	20.5	mA
G_p	電力利得	$f = 1\text{ GHz}$	21.0	23.0	26.0	dB
		$f = 2.2\text{ GHz}$	22.0	24.0	27.0	
ISL	アイソレーション	$f = 1\text{ GHz}$	27.0	31.5	–	dB
		$f = 2.2\text{ GHz}$	27.0	31.5	–	
RLin	入力リターンロス	$f = 1\text{ GHz}$	16.0	20.5	–	dB
		$f = 2.2\text{ GHz}$	10.0	15.0	–	
RLout	出力リターンロス	$f = 1\text{ GHz}$	15.0	20.0	–	dB
		$f = 2.2\text{ GHz}$	10.0	14.0	–	
NF	雑音指数	$f = 1\text{ GHz}$	–	4.3	5.0	dB
		$f = 2.2\text{ GHz}$	–	4.3	5.0	
$P_o(1\text{dB})$	1 dB 利得圧縮点出力電力	$f = 1\text{ GHz}$	4.0	6.4	–	dBm
		$f = 2.2\text{ GHz}$	2.0	4.2	–	
f_u	動作周波数帯域	1 GHz のゲインより 3 dB 低下	–	3.6	–	GHz

Product parametric performance is indicated in the Electrical Characteristics for the listed test conditions, unless otherwise noted. Product performance may not be indicated by the Electrical Characteristics if operated under different conditions.

(参考訳)

製品パラメータは、特別な記述が無い限り、記載されたテスト条件に対する電気的特性で示しています。異なる条件下で製品動作を行った時には、電気的特性で示している特性を得られない場合があります。

注： 本製品は、高周波プロセスを使用しています。

静電気等の影響を受けやすくなっていますので取り扱いにご注意下さい。

測定回路図



図 1. 測定回路図

SMA3109

評価基板

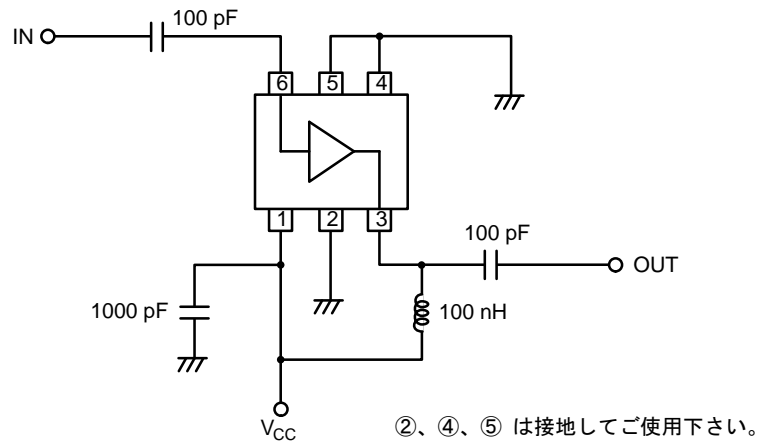

図 2. 評価基板



図 3. I_{CC} - V_{CC}

SMA3109

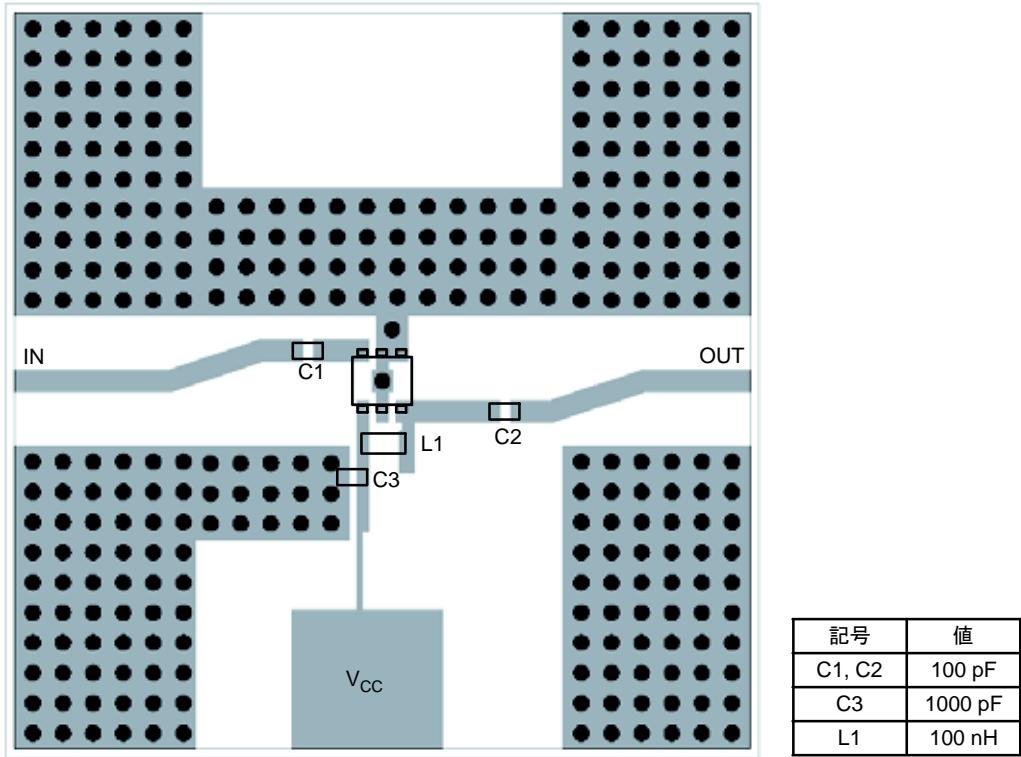

図 4. $G_p - f$

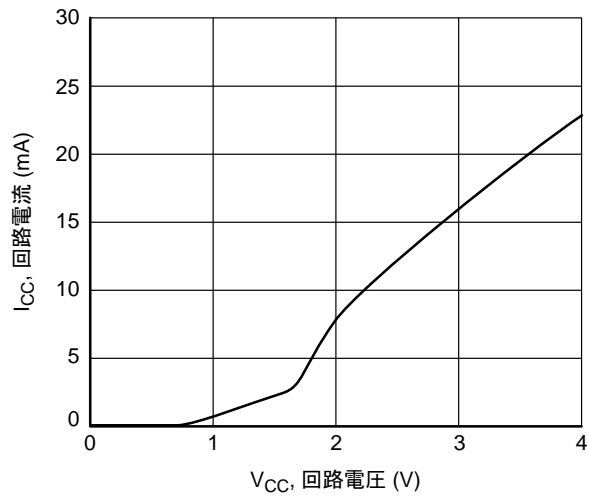

図 5. $RL_{in} - f$

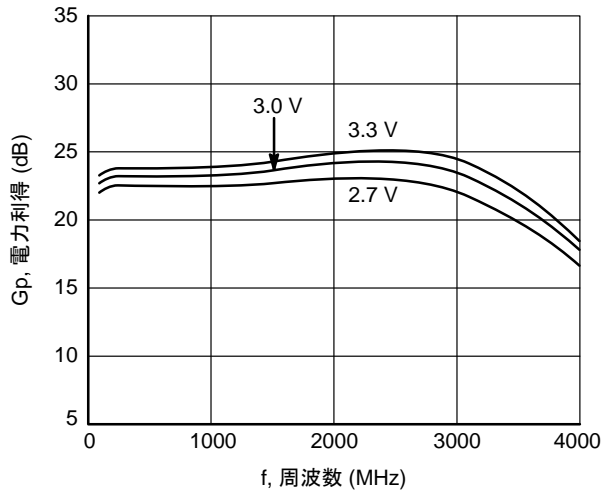

図 6. $ISL - f$

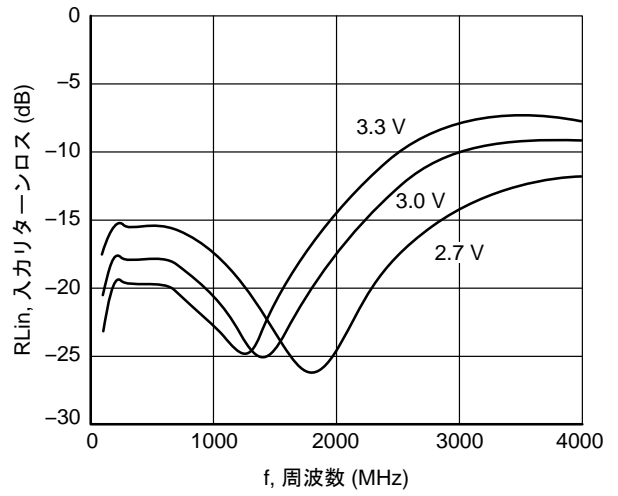

図 7. $RL_{out} - f$

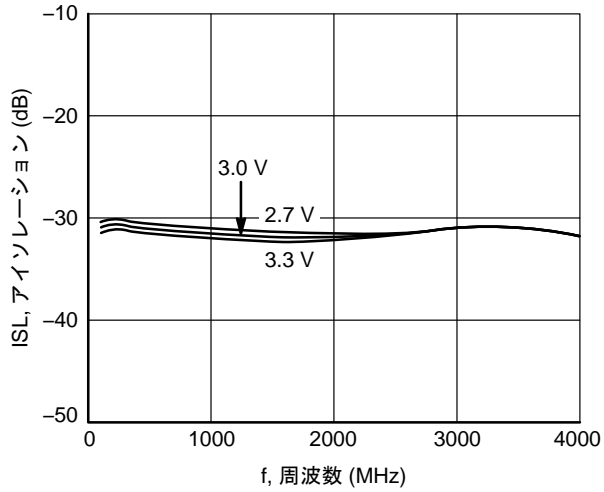

図 8. $P_{out} - P_{in}$

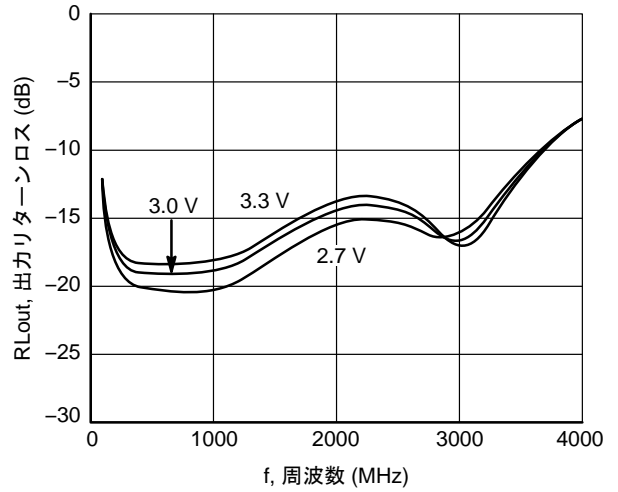

図 9. $P_{out} - P_{in}$

SMA3109

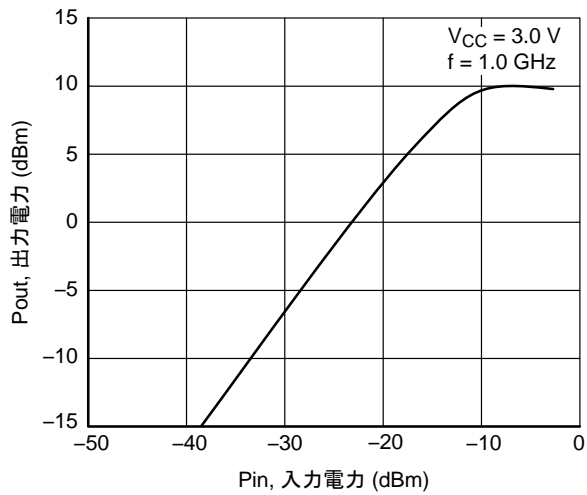
Sパラメータ

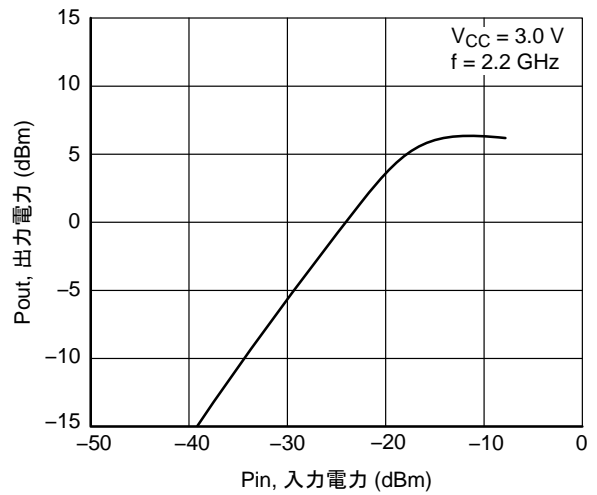

図 10. Sパラメータ

ORDERING INFORMATION

Device	Specific Device Marking	パッケージ名 (JEITA, JEDEC)	パッケージ名	Shipping†
SMA3109-TL-E	LF	SC-88FL (Pb-Free)	MCPH6 (Pb-Free)	3000 / Tape & Reel

†For Information On Tape And Reel Specifications, Including Part Orientation And Tape Sizes, Please Refer To Our Tape And Reel Packaging Specifications Brochure, Brd8011/D.

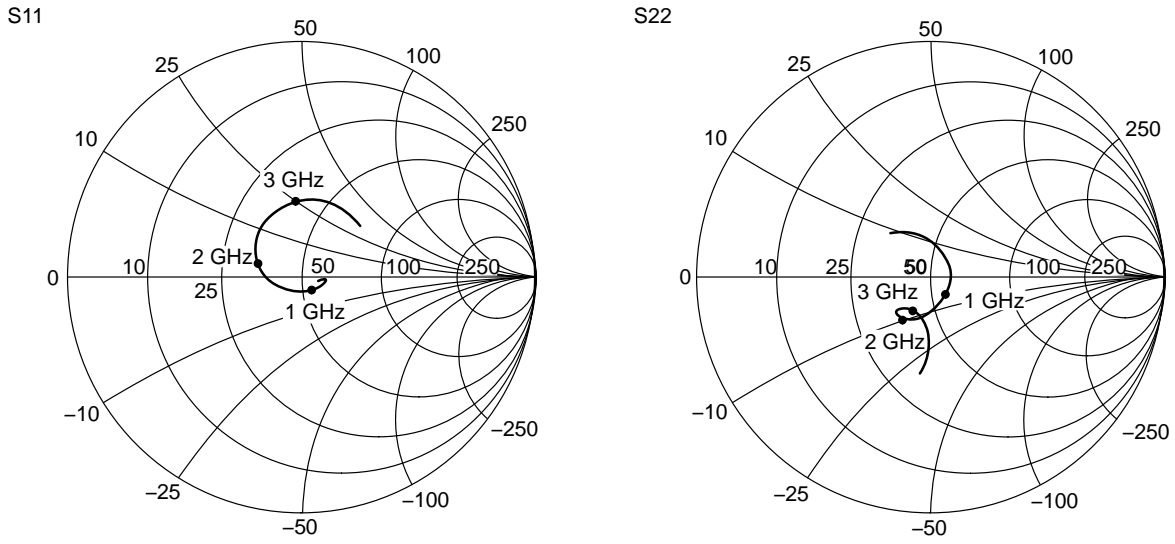
MECHANICAL CASE OUTLINE PACKAGE DIMENSIONS

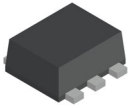

SC-88FL / MCPH6
CASE 419AS
ISSUE A

DATE 28 SEP 2022

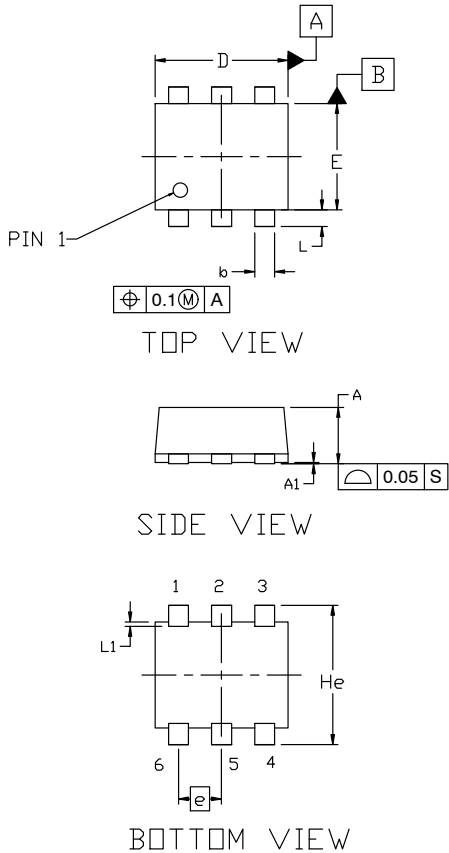

NOTES:

1. NO INDUSTRY STANDARD APPLIES TO THIS PACKAGE.
2. ALL DIMENSIONS ARE IN MILLIMETERS.
3. DIMENSIONS ARE EXCLUSIVE OF BURRS, MOLD FLASH AND THE BAR PROTRUSIONS.

DIM	MILLIMETERS		
	MIN.	NOM.	MAX.
A	0.80	0.85	0.90
A1	0.00	---	0.02
b	0.25	0.30	0.40
c	0.12	0.15	0.25
D	1.94	2.00	2.06
E	1.54	1.60	1.66
He	2.05	2.10	2.15
L	0.19	0.25	0.31
L1	0.00	0.07	0.12
e	0.65 BSC		

GENERIC MARKING DIAGRAM*

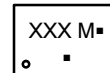

- XXX = Specific Device Code
- M = Date Code
- = Pb-Free Package

(Note: Microdot may be in either location)

*This information is generic. Please refer to device data sheet for actual part marking. Pb-Free indicator, "G" or microdot "▪", may or may not be present. Some products may not follow the Generic Marking.

DOCUMENT NUMBER:	98AON65646E	Electronic versions are uncontrolled except when accessed directly from the Document Repository. Printed versions are uncontrolled except when stamped "CONTROLLED COPY" in red.
DESCRIPTION:	SC-88FL / MCPH6	PAGE 1 OF 1

onsemi and onsemi are trademarks of Semiconductor Components Industries, LLC dba onsemi or its subsidiaries in the United States and/or other countries. onsemi reserves the right to make changes without further notice to any products herein. onsemi makes no warranty, representation or guarantee regarding the suitability of its products for any particular purpose, nor does onsemi assume any liability arising out of the application or use of any product or circuit, and specifically disclaims any and all liability, including without limitation special, consequential or incidental damages. onsemi does not convey any license under its patent rights nor the rights of others.

onsemi, **Onsemi**, and other names, marks, and brands are registered and/or common law trademarks of Semiconductor Components Industries, LLC dba "**onsemi**" or its affiliates and/or subsidiaries in the United States and/or other countries. **onsemi** owns the rights to a number of patents, trademarks, copyrights, trade secrets, and other intellectual property. A listing of **onsemi**'s product/patent coverage may be accessed at www.onsemi.com/site/pdf/Patent-Marking.pdf. **onsemi** reserves the right to make changes at any time to any products or information herein, without notice. The information herein is provided "as-is" and **onsemi** makes no warranty, representation or guarantee regarding the accuracy of the information, product features, availability, functionality, or suitability of its products for any particular purpose, nor does **onsemi** assume any liability arising out of the application or use of any product or circuit, and specifically disclaims any and all liability, including without limitation special, consequential or incidental damages. Buyer is responsible for its products and applications using **onsemi** products, including compliance with all laws, regulations and safety requirements or standards, regardless of any support or applications information provided by **onsemi**. "Typical" parameters which may be provided in **onsemi** data sheets and/or specifications can and do vary in different applications and actual performance may vary over time. All operating parameters, including "Typicals" must be validated for each customer application by customer's technical experts. **onsemi** does not convey any license under any of its intellectual property rights nor the rights of others. **onsemi** products are not designed, intended, or authorized for use as a critical component in life support systems or any FDA Class 3 medical devices or medical devices with a same or similar classification in a foreign jurisdiction or any devices intended for implantation in the human body. Should Buyer purchase or use **onsemi** products for any such unintended or unauthorized application, Buyer shall indemnify and hold **onsemi** and its officers, employees, subsidiaries, affiliates, and distributors harmless against all claims, costs, damages, and expenses, and reasonable attorney fees arising out of, directly or indirectly, any claim of personal injury or death associated with such unintended or unauthorized use, even if such claim alleges that **onsemi** was negligent regarding the design or manufacture of the part. **onsemi** is an Equal Opportunity/Affirmative Action Employer. This literature is subject to all applicable copyright laws and is not for resale in any manner.

ADDITIONAL INFORMATION

TECHNICAL PUBLICATIONS:

Technical Library: www.onsemi.com/design/resources/technical-documentation
onsemi Website: www.onsemi.com

ONLINE SUPPORT: www.onsemi.com/support

For additional information, please contact your local Sales Representative at www.onsemi.com/support/sales