

3-Level NPC Inverter Module

NXH450N65L4Q2F2

The NXH450N65L4Q2F2 is a power module containing a I– type neutral point clamped three–level inverter. The integrated field stop trench IGBTs and FRDs provide lower conduction losses and switching losses, enabling designers to achieve high efficiency and superior reliability.

Features

- Neutral Point Clamped Three–Level Inverter Module
- 650 V Field Stop 4 IGBTs
- Low Inductive Layout
- Solderable Pins
- Thermistor

Typical Applications

- Solar Inverters
- Uninterruptable Power Supplies Systems

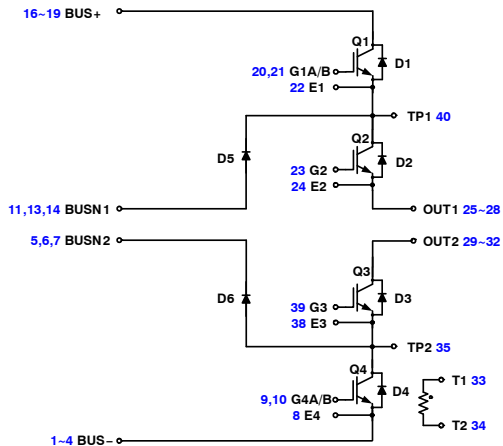
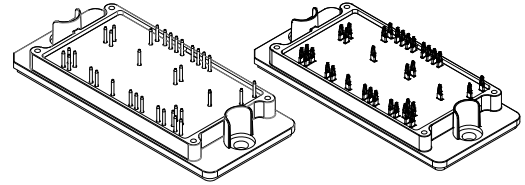

Figure 1. Schematic Diagram



PIM40, Q2PACK
CASE 180BE

PIM36, Q2PACK
CASE 180CD

MARKING DIAGRAM

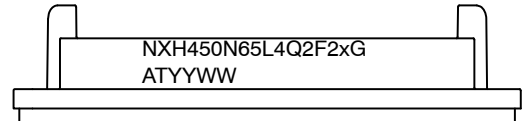

NXH450N65L4Q2F2x = Specific Device Code
G = Pb–Free Package
AT = Assembly & Test Site Code
YYWW = Year and Work Week Code

PIN ASSIGNMENTS

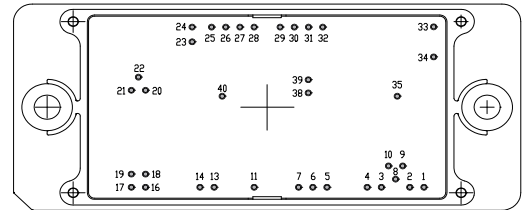

ORDERING INFORMATION

See detailed ordering and shipping information in the dimensions section on page 5 of this data sheet.

NXH450N65L4Q2F2

Table 1. MAXIMUM RATINGS (Note 1)

Rating	Symbol	Value	Unit
OUTER IGBT (Q1-1, Q1-2, Q4-1, Q4-2)			
Collector-Emitter Voltage	V_{CES}	650	V
Gate-Emitter Voltage Positive Transient Gate-Emitter Voltage ($t_{pulse} = 5 \mu s, D < 0.10$)	V_{GE}	± 20 30	V
Continuous Collector Current @ $T_c = 80^\circ C$ ($T_J = 175^\circ C$)	I_C	167	A
Pulsed Collector Current ($T_J = 175^\circ C$)	I_{Cpulse}	501	A
Maximum Power Dissipation ($T_J = 175^\circ C$)	P_{tot}	365	W
Maximum Operating Junction Temperature	T_{JMAX}	150	$^\circ C$

INNER IGBT (Q2, Q3)

Collector-Emitter Voltage	V_{CES}	650	V
Gate-Emitter Voltage Positive Transient Gate-Emitter Voltage ($t_{pulse} = 5 \mu s, D < 0.10$)	V_{GE}	± 20 30	V
Continuous Collector Current @ $T_c = 80^\circ C$ ($T_J = 175^\circ C$)	I_C	280	A
Pulsed Collector Current ($T_J = 175^\circ C$)	I_{Cpulse}	840	A
Maximum Power Dissipation ($T_J = 175^\circ C$)	P_{tot}	633	W
Maximum Operating Junction Temperature	T_{JMAX}	150	$^\circ C$

NEUTRAL POINT DIODE (D5, D6)

Peak Repetitive Reverse Voltage	V_{RRM}	650	V
Continuous Forward Current @ $T_c = 80^\circ C$ ($T_J = 175^\circ C$)	I_F	271	A
Repetitive Peak Forward Current ($T_J = 175^\circ C$)	I_{FRM}	813	A
Maximum Power Dissipation ($T_J = 175^\circ C$)	P_{tot}	559	W
Maximum Operating Junction Temperature	T_{JMAX}	150	$^\circ C$

INVERSE DIODES (D1, D2, D3, D4)

Peak Repetitive Reverse Voltage	V_{RRM}	650	V
Continuous Forward Current @ $T_c = 80^\circ C$ ($T_J = 175^\circ C$)	I_F	131	A
Repetitive Peak Forward Current ($t_p = 1 ms$)	I_{FRM}	450	A
Maximum Power Dissipation ($T_J = 175^\circ C$)	P_{tot}	288	W
Maximum Operating Junction Temperature	T_{JMAX}	150	$^\circ C$

THERMAL PROPERTIES

Storage Temperature Range	T_{stg}	-40 to 150	$^\circ C$
---------------------------	-----------	------------	------------

INSULATION PROPERTIES

Isolation Test Voltage, $t = 1 s, 50 Hz$	V_{is}	4000	V_{RMS}
Creepage Distance		12.7	mm

Stresses exceeding those listed in the Maximum Ratings table may damage the device. If any of these limits are exceeded, device functionality should not be assumed, damage may occur and reliability may be affected.

1. Refer to ELECTRICAL CHARACTERISTICS, RECOMMENDED OPERATING RANGES and/or APPLICATION INFORMATION for Safe Operating parameters.

Table 2. RECOMMENDED OPERATING RANGES

Rating	Symbol	Min	Max	Unit
Module Operating Junction Temperature	T_J	-40	T_{JMAX}	$^\circ C$

Functional operation above the stresses listed in the Recommended Operating Ranges is not implied. Extended exposure to stresses beyond the Recommended Operating Ranges limits may affect device reliability.

NXH450N65L4Q2F2

Table 3. ELECTRICAL CHARACTERISTICS ($T_J = 25^\circ\text{C}$ unless otherwise noted)

Parameter	Test Conditions	Symbol	Min	Typ	Max	Unit
OUTER IGBT (Q1-1, Q1-2, Q4-1, Q4-2)						
Collector-Emitter Cutoff Current	$V_{GE} = 0\text{ V}, V_{CE} = 650\text{ V}$	I_{CES}	-	-	300	μA
Collector-Emitter Saturation Voltage	$V_{GE} = 15\text{ V}, I_C = 225\text{ A}, T_J = 25^\circ\text{C}$	$V_{CE(sat)}$	-	1.49	2.2	V
	$V_{GE} = 15\text{ V}, I_C = 225\text{ A}, T_J = 150^\circ\text{C}$		-	1.70	-	
Gate-Emitter Threshold Voltage	$V_{GE} = V_{CE}, I_C = 2.25\text{ mA}$	$V_{GE(TH)}$	3.1	4.0	5.2	V
Gate Leakage Current	$V_{GE} = 20\text{ V}, V_{CE} = 0\text{ V}$	I_{GES}	-	-	600	nA
Turn-on Delay Time	$T_J = 25^\circ\text{C}$ $V_{CE} = 400\text{ V}, I_C = 100\text{ A}$ $V_{GE} = -5\text{ V to } +15\text{ V}, R_{G(on)} = 15\ \Omega,$ $R_{G(off)} = 15\ \Omega$	$t_{d(on)}$	-	163	-	ns
Rise Time		t_r	-	45	-	
Turn-off Delay Time		$t_{d(off)}$	-	831	-	
Fall Time		t_f	-	61	-	
Turn-on Switching Loss per Pulse		E_{on}	-	2.344	-	
Turn off Switching Loss per Pulse	E_{off}	-	3.125	-		
Turn-on Delay Time	$T_J = 125^\circ\text{C}$ $V_{CE} = 400\text{ V}, I_C = 100\text{ A}$ $V_{GE} = -5\text{ V to } +15\text{ V}, R_{G(on)} = 15\ \Omega,$ $R_{G(off)} = 15\ \Omega$	$t_{d(on)}$	-	141	-	ns
Rise Time		t_r	-	51	-	
Turn-off Delay Time		$t_{d(off)}$	-	898	-	
Fall Time		t_f	-	80	-	
Turn-on Switching Loss per Pulse		E_{on}	-	3.75	-	
Turn off Switching Loss per Pulse	E_{off}	-	2.97	-		
Input Capacitance	$V_{CE} = 20\text{ V}, V_{GE} = 0\text{ V}, f = 10\text{ kHz}$	C_{ies}	-	14630	-	pF
Output Capacitance		C_{oes}	-	230	-	
Reverse Transfer Capacitance		C_{res}	-	64	-	
Total Gate Charge	$V_{CE} = 480\text{ V}, I_C = 225\text{ A}, V_{GE} = 0 \sim +15\text{ V}$	Q_g	-	452	-	nC
Thermal Resistance - Chip-to-Heatsink	Thermal grease, Thickness = 2 Mil $\pm 2\%$, $\lambda = 2.8\text{ W/mK}$	R_{thJH}	-	0.45	-	$^\circ\text{C/W}$
Thermal Resistance - Chip-to-Case		R_{thJC}	-	0.26	-	$^\circ\text{C/W}$
NEUTRAL POINT DIODE (D5, D6)						
Diode Forward Voltage	$I_F = 375\text{ A}, T_J = 25^\circ\text{C}$	V_F	-	1.80	2.3	V
	$I_F = 375\text{ A}, T_J = 150^\circ\text{C}$		-	1.77	-	
Reverse Recovery Time	$T_J = 25^\circ\text{C}$ $V_{CE} = 400\text{ V}, I_C = 100\text{ A}$ $V_{GE} = -5\text{ V to } +15\text{ V}, R_G = 15\ \Omega$	t_{rr}	-	46	-	ns
Reverse Recovery Charge		Q_{rr}	-	1.5	-	μC
Peak Reverse Recovery Current		I_{RRM}	-	53	-	A
Peak Rate of Fall of Recovery Current		di/dt	-	2541	-	$\text{A}/\mu\text{s}$
Reverse Recovery Energy		E_{rr}	-	0.3	-	mJ
Reverse Recovery Time	$T_J = 125^\circ\text{C}$ $V_{CE} = 400\text{ V}, I_C = 100\text{ A}$ $V_{GE} = -5\text{ V to } +15\text{ V}, R_G = 15\ \Omega$	t_{rr}	-	75	-	ns
Reverse Recovery Charge		Q_{rr}	-	4	-	μC
Peak Reverse Recovery Current		I_{RRM}	-	96	-	A
Peak Rate of Fall of Recovery Current		di/dt	-	2500	-	$\text{A}/\mu\text{s}$
Reverse Recovery Energy		E_{rr}	-	0.83	-	mJ
Thermal Resistance - Chip-to-Heatsink	Thermal grease, Thickness = 2 Mil $\pm 2\%$, $\lambda = 2.8\text{ W/mK}$	R_{thJH}	-	0.37	-	$^\circ\text{C/W}$
Thermal Resistance - Chip-to-Case		R_{thJC}	-	0.17	-	$^\circ\text{C/W}$

NXH450N65L4Q2F2

Table 3. ELECTRICAL CHARACTERISTICS ($T_J = 25^\circ\text{C}$ unless otherwise noted) (continued)

Parameter	Test Conditions	Symbol	Min	Typ	Max	Unit	
INNER IGBT (Q2, Q3)							
Collector–Emitter Cutoff Current	$V_{GE} = 0\text{ V}, V_{CE} = 650\text{ V}$	I_{CES}	–	–	300	μA	
Collector–Emitter Saturation Voltage	$V_{GE} = 15\text{ V}, I_C = 375\text{ A}, T_J = 25^\circ\text{C}$	$V_{CE(sat)}$	–	1.49	2.2	V	
	$V_{GE} = 15\text{ V}, I_C = 375\text{ A}, T_J = 150^\circ\text{C}$		–	1.72	–		
Gate–Emitter Threshold Voltage	$V_{GE} = V_{CE}, I_C = 3.75\text{ mA}$	$V_{GE(TH)}$	3.1	4.1	5.2	V	
Gate Leakage Current	$V_{GE} = 20\text{ V}, V_{CE} = 0\text{ V}$	I_{GES}	–	–	1000	nA	
Turn-on Delay Time	$T_J = 25^\circ\text{C}$ $V_{CE} = 400\text{ V}, I_C = 100\text{ A}$ $V_{GE} = -5\text{ V to } +15\text{ V}, R_{G(on)} = 15\ \Omega,$ $R_{G(off)} = 15\ \Omega$	$t_{d(on)}$	–	134	–	ns	
Rise Time		t_r	–	47	–		
Turn-off Delay Time		$t_{d(off)}$	–	709	–		
Fall Time		t_f	–	32	–		
Turn-on Switching Loss per Pulse		E_{on}	–	1.72	–		mJ
Turn off Switching Loss per Pulse		E_{off}	–	2.65	–		
Turn-on Delay Time	$T_J = 125^\circ\text{C}$ $V_{CE} = 400\text{ V}, I_C = 100\text{ A}$ $V_{GE} = -5\text{ V to } +15\text{ V}, R_{G(on)} = 15\ \Omega,$ $R_{G(off)} = 15\ \Omega$	$t_{d(on)}$	–	118	–	ns	
Rise Time		t_r	–	52	–		
Turn-off Delay Time		$t_{d(off)}$	–	765	–		
Fall Time		t_f	–	29	–		
Turn-on Switching Loss per Pulse		E_{on}	–	2.34	–		mJ
Turn off Switching Loss per Pulse		E_{off}	–	2.89	–		
Input Capacitance	$V_{CE} = 20\text{ V}, V_{GE} = 0\text{ V}, f = 10\text{ kHz}$	C_{ies}	–	24383	–	pF	
Output Capacitance		C_{oes}	–	383	–		
Reverse Transfer Capacitance		C_{res}	–	105	–		
Total Gate Charge	$V_{CE} = 480\text{ V}, I_C = 375\text{ A}, V_{GE} = 0 \sim +15\text{ V}$	Q_g	–	753	–	nC	
Thermal Resistance – Chip–to–Heatsink	Thermal grease, Thickness = 2 Mil $\pm 2\%$, $\lambda = 2.8\text{ W/mK}$	R_{thJH}	–	0.31	–	$^\circ\text{C/W}$	
Thermal Resistance – Chip–to–Case		R_{thJC}	–	0.15	–	$^\circ\text{C/W}$	
INVERSE DIODES (D1, D2, D3, D4)							
Diode Forward Voltage	$I_F = 150\text{ A}, T_J = 25^\circ\text{C}$	V_F	–	1.78	2.3	V	
	$I_F = 150\text{ A}, T_J = 150^\circ\text{C}$		–	1.77	–		
Reverse Recovery Time	$T_J = 25^\circ\text{C}$ $V_{CE} = 400\text{ V}, I_C = 100\text{ A}$ $V_{GE} = -5\text{ V to } +15\text{ V}, R_G = 15\ \Omega$	t_{rr}	–	43	–	ns	
Reverse Recovery Charge		Q_{rr}	–	1.14	–	μC	
Peak Reverse Recovery Current		I_{RRM}	–	46	–	A	
Peak Rate of Fall of Recovery Current		di/dt	–	2473	–	$\text{A}/\mu\text{s}$	
Reverse Recovery Energy		E_{rr}	–	0.313	–	mJ	
Reverse Recovery Time		$T_J = 125^\circ\text{C}$ $V_{CE} = 400\text{ V}, I_C = 100\text{ A}$ $V_{GE} = -5\text{ V to } +15\text{ V}, R_G = 15\ \Omega$	t_{rr}	–	67	–	ns
Reverse Recovery Charge	Q_{rr}		–	2.5	–	μC	
Peak Reverse Recovery Current	I_{RRM}		–	66	–	A	
Peak Rate of Fall of Recovery Current	di/dt		–	2317	–	$\text{A}/\mu\text{s}$	
Reverse Recovery Energy	E_{rr}		–	0.625	–	mJ	
Thermal Resistance – Chip–to–Heatsink	Thermal grease, Thickness = 2 Mil $\pm 2\%$, $\lambda = 2.8\text{ W/mK}$		R_{thJH}	–	0.58	–	$^\circ\text{C/W}$
Thermal Resistance – Chip–to–Case		R_{thJC}	–	0.33	–	$^\circ\text{C/W}$	

NXH450N65L4Q2F2

Table 3. ELECTRICAL CHARACTERISTICS ($T_J = 25^\circ\text{C}$ unless otherwise noted) (continued)

Parameter	Test Conditions	Symbol	Min	Typ	Max	Unit
THERMISTOR CHARACTERISTICS						
Nominal Resistance	$T = 25^\circ\text{C}$	R_{25}	–	22	–	$k\Omega$
Nominal Resistance	$T = 100^\circ\text{C}$	R_{100}	–	1486	–	Ω
Deviation of R25		$\Delta R/R$	–5	–	5	%
Power Dissipation		P_D	–	200	–	mW
Power Dissipation Constant			–	2	–	mW/K
B-value	$B(25/50)$, tolerance $\pm 3\%$		–	3950	–	K
B-value	$B(25/100)$, tolerance $\pm 3\%$		–	3998	–	K

Product parametric performance is indicated in the Electrical Characteristics for the listed test conditions, unless otherwise noted. Product performance may not be indicated by the Electrical Characteristics if operated under different conditions.

ORDERING INFORMATION

Orderable Part Number	Marking	Package	Shipping
NXH450N65L4Q2F2SG	NXH450N65L4Q2F2SG	PIM40, Q2PACK (Pb-Free and Halide-Free)	12 Units / Blister Tray
NXH450N65L4Q2F2PG	NXH450N65L4Q2F2PG	PIM436 Q2PACK (Pb-Free and Halide-Free)	12 Units / Blister Tray

NXH450N65L4Q2F2

TYPICAL CHARACTERISTICS – IGBT Q1-1, Q1-2, Q4-1, Q4-2 AND DIODE D1, D4

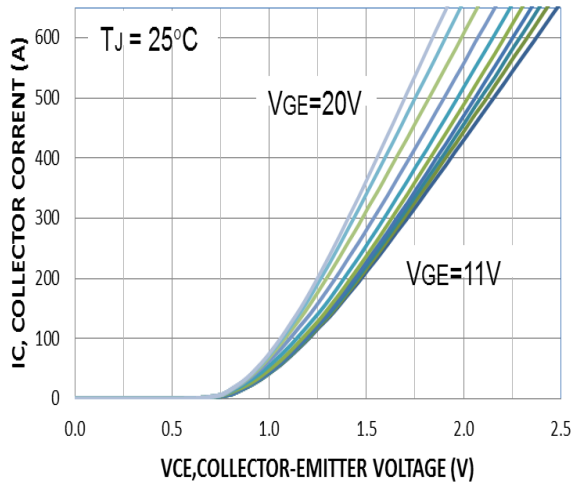

Figure 2. Typical Output Characteristics

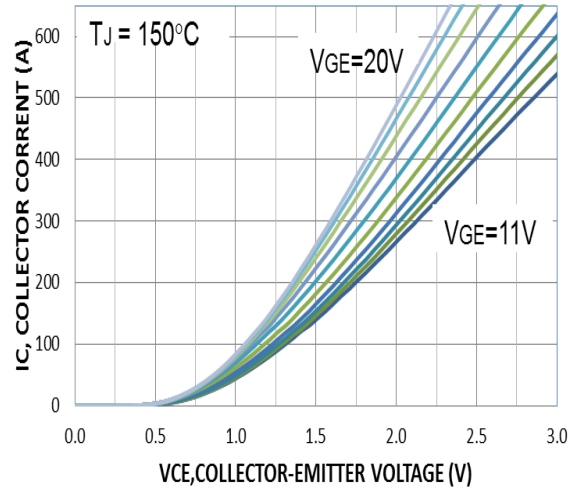

Figure 3. Typical Output Characteristics

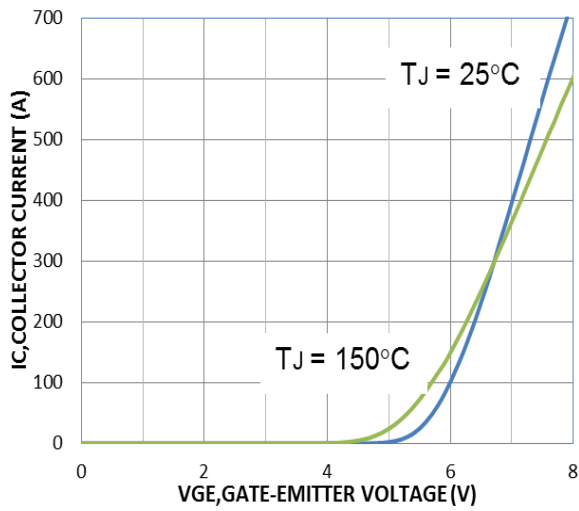

Figure 4. Typical Transfer Characteristics

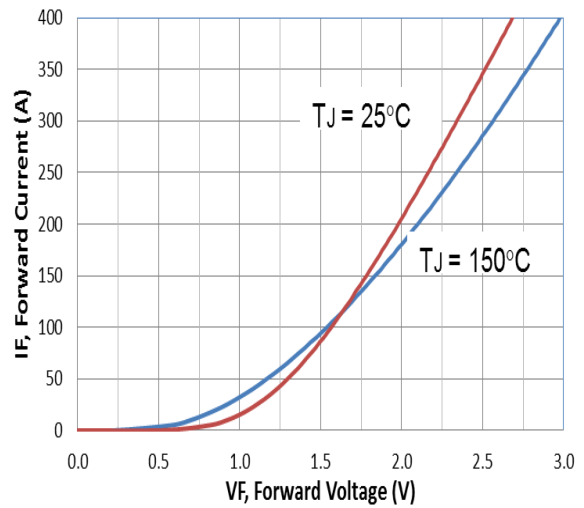

Figure 5. Typical Transfer Characteristics

NXH450N65L4Q2F2

TYPICAL CHARACTERISTICS – IGBT Q1-1, Q1-2, Q4-1, Q4-2 AND DIODE D1, D4

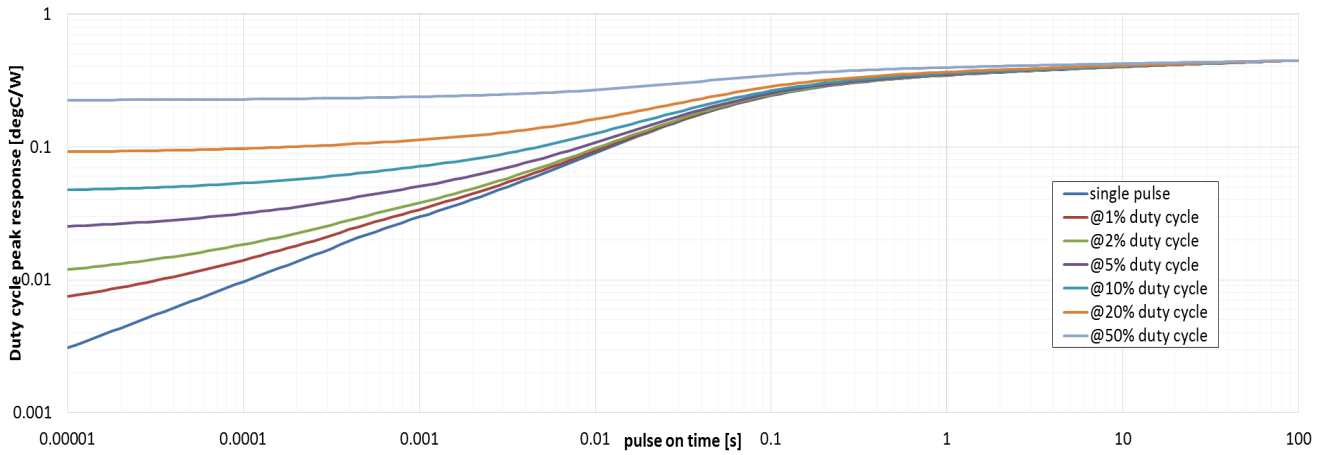

Figure 6. Transient Thermal Impedance (Q1-1, Q1-2, Q4-1, Q4-2)

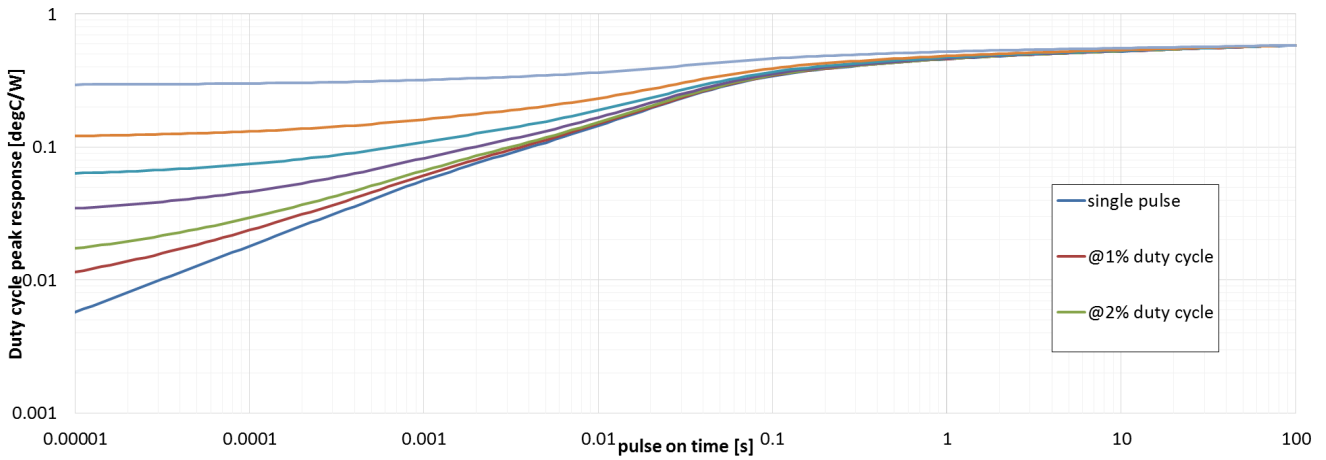

Figure 7. Transient Thermal Impedance (D1, D4)

NXH450N65L4Q2F2

TYPICAL CHARACTERISTICS – IGBT Q1-1, Q1-2, Q4-1, Q4-2 AND DIODE D1, D4

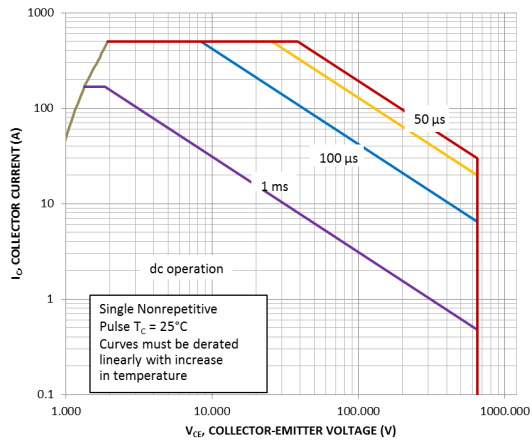

Figure 8. FBSOA (Q1-1, Q1-2, Q4-1, Q4-2)

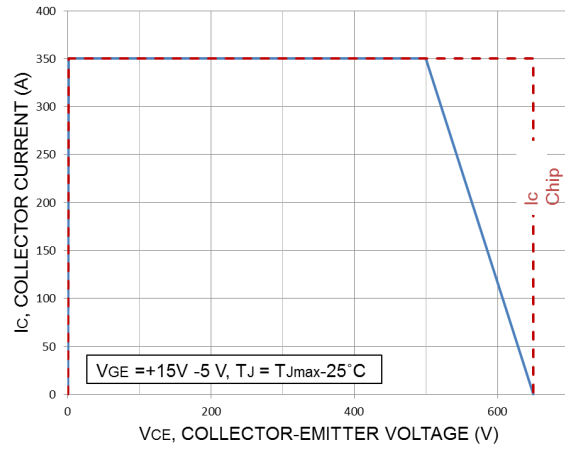

Figure 9. RBSOA (Q1-1, Q1-2, Q4-1, Q4-2)

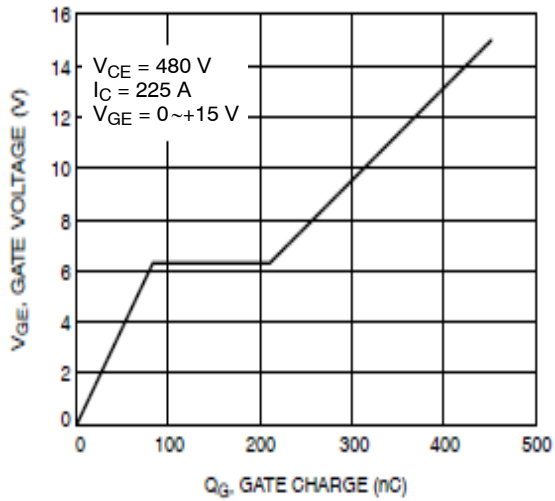

Figure 10. Gate Voltage vs. Gate Charge

NXH450N65L4Q2F2

TYPICAL CHARACTERISTICS – IGBT Q2, Q3 AND DIODE D2, D3

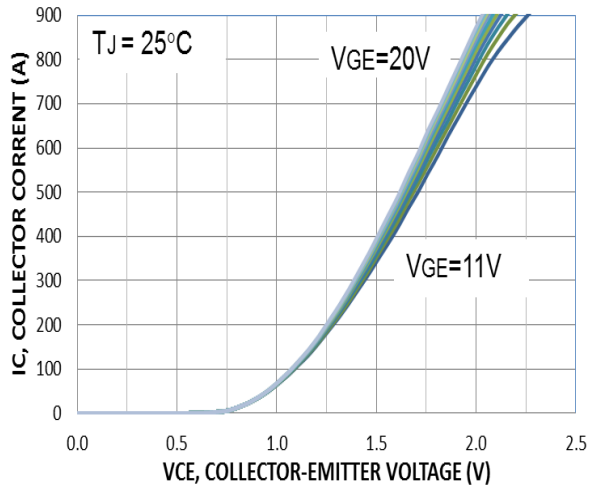

Figure 11. Typical Output Characteristics

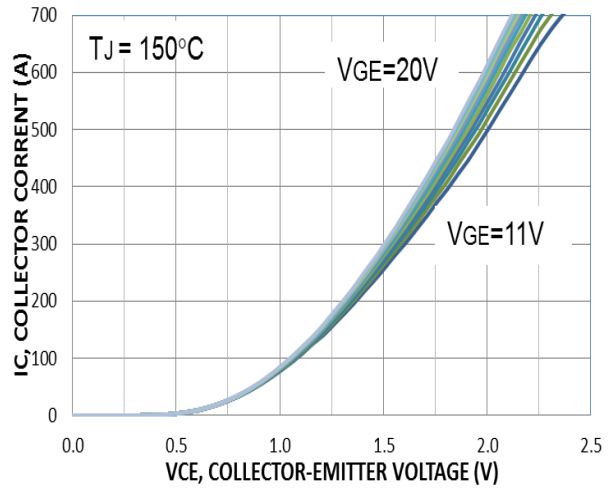

Figure 12. Typical Output Characteristics

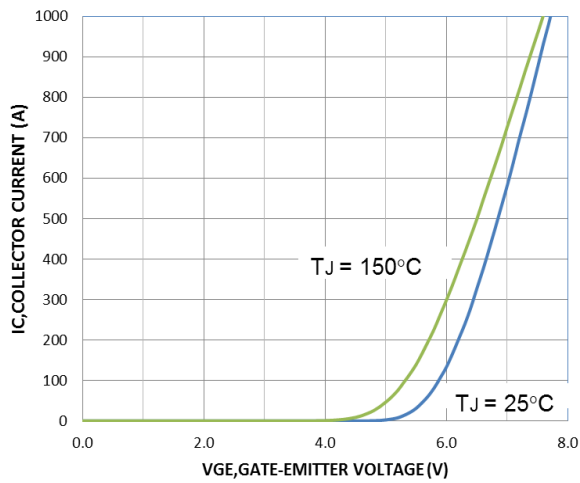

Figure 13. Typical Transfer Characteristics

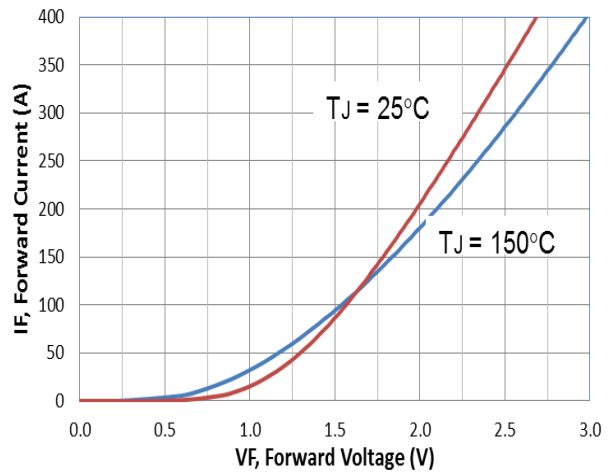

Figure 14. Typical Transfer Characteristics

NXH450N65L4Q2F2

TYPICAL CHARACTERISTICS – IGBT Q2, Q3 AND DIODE D2, D3

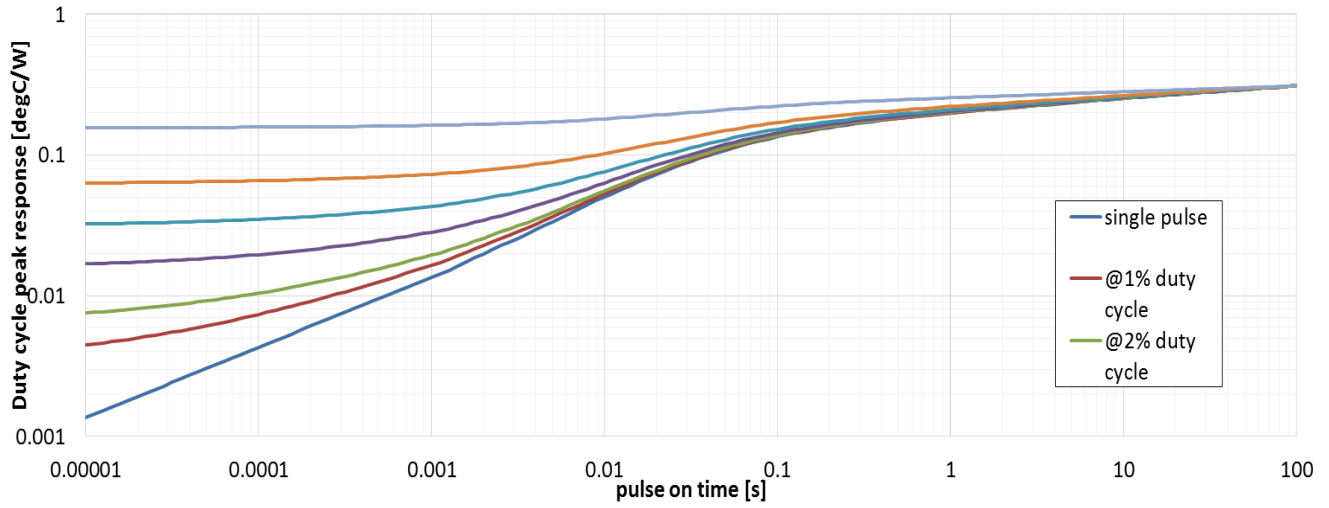

Figure 15. Transient Thermal Impedance (Q2, Q3)

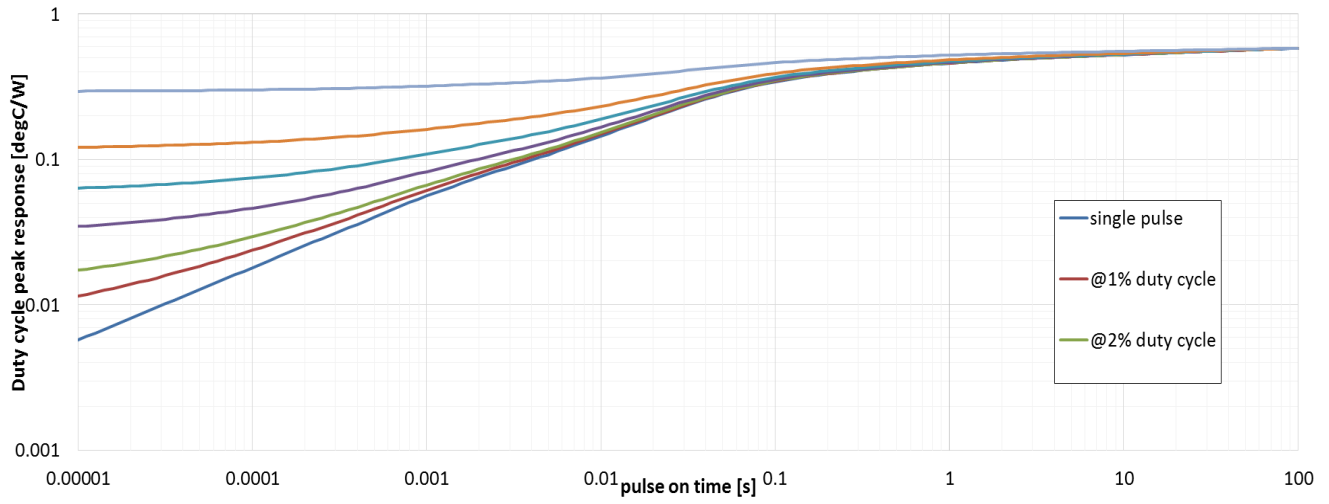

Figure 16. Transient Thermal Impedance (D2, D3)

NXH450N65L4Q2F2

TYPICAL CHARACTERISTICS – IGBT Q2, Q3 AND DIODE D2, D3

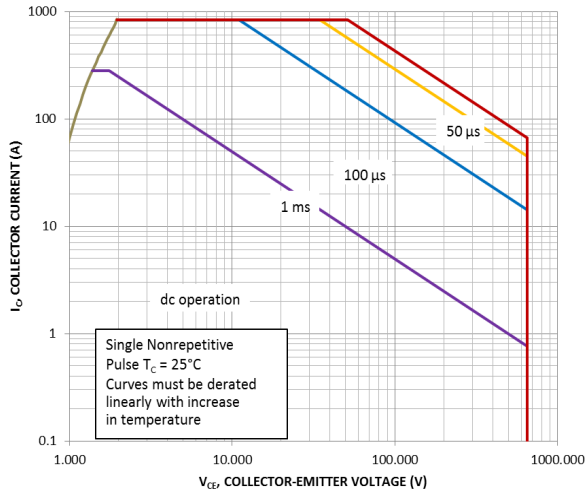

Figure 17. FBSOA (Q2, Q3)

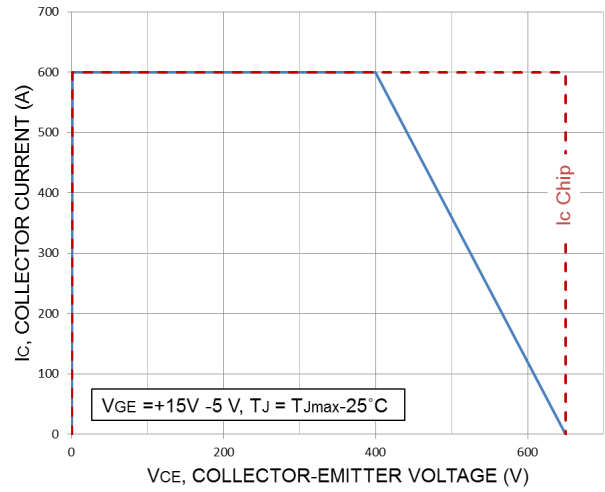

Figure 18. RBSOA (Q2, Q3)

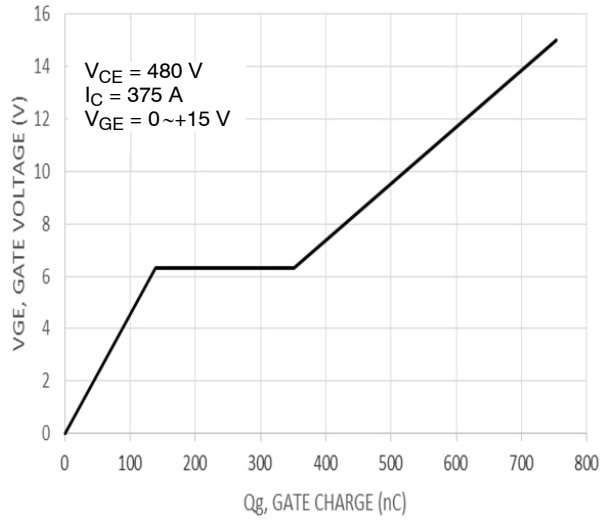

Figure 19. Gate Voltage vs. Gate Charge

NXH450N65L4Q2F2

TYPICAL CHARACTERISTICS – DIODE D5, D6

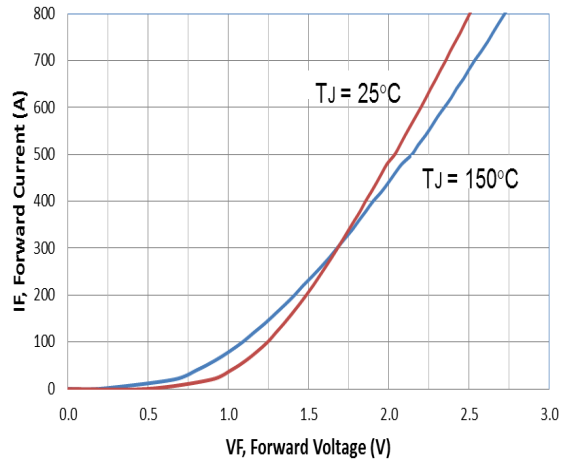

Figure 20. Diode Forward Characteristics

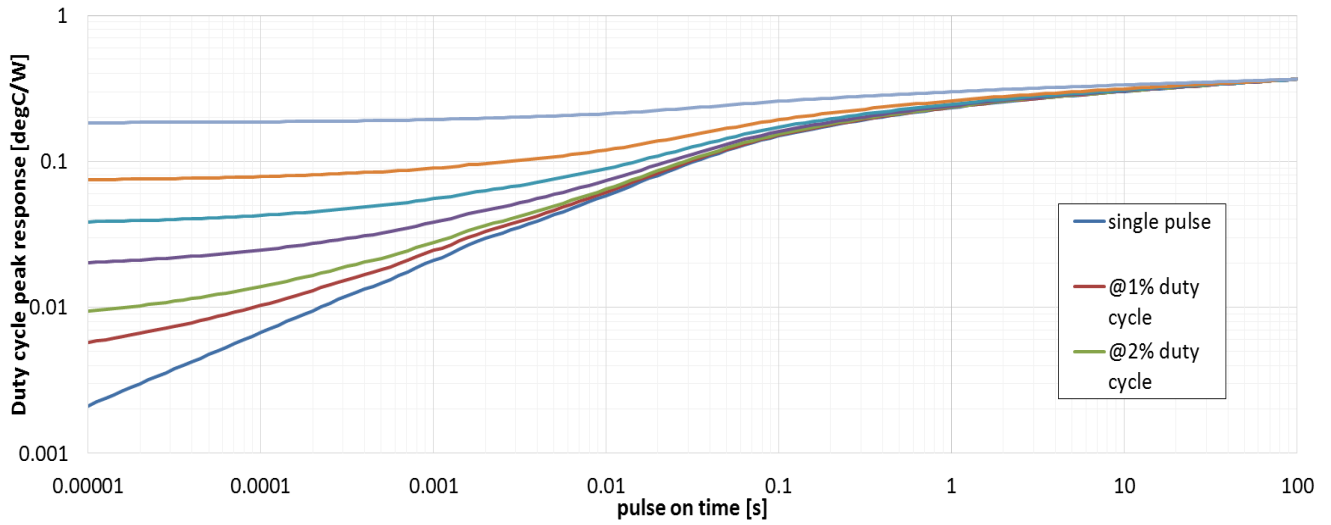

Figure 21. Transient Thermal Impedance (D5, D6)

NXH450N65L4Q2F2

TYPICAL CHARACTERISTICS – Q1/Q4 IGBT COMUTATES D5/D6 DIODE

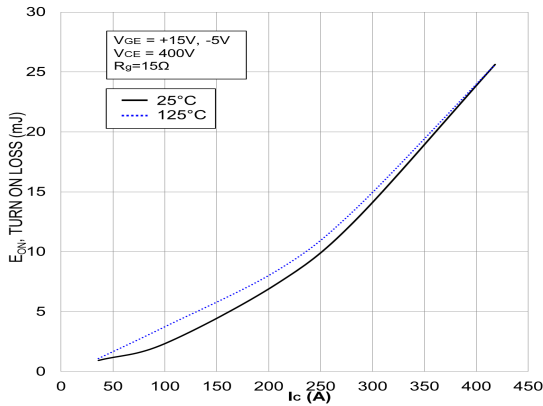

Figure 22. Typical Switching Loss Eon vs. IC

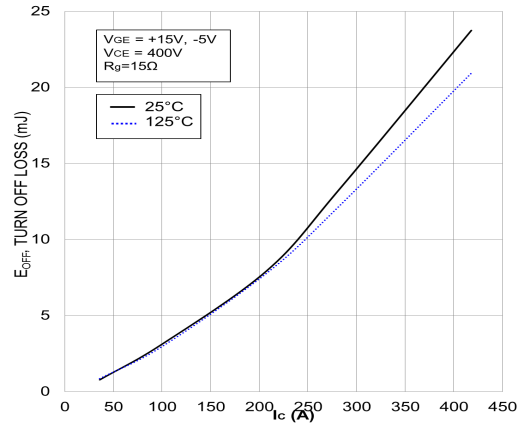

Figure 23. Typical Switching Loss Eoff vs. IC

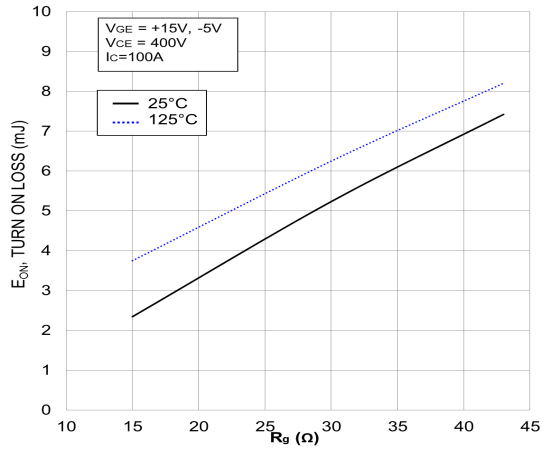

Figure 24. Typical Switching Loss Eon vs. R_G

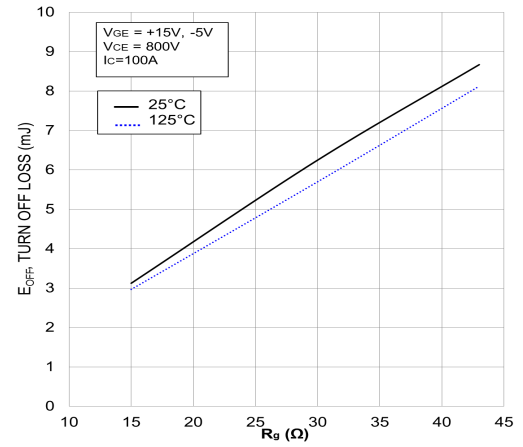

Figure 25. Typical Switching Loss Eoff vs. R_G

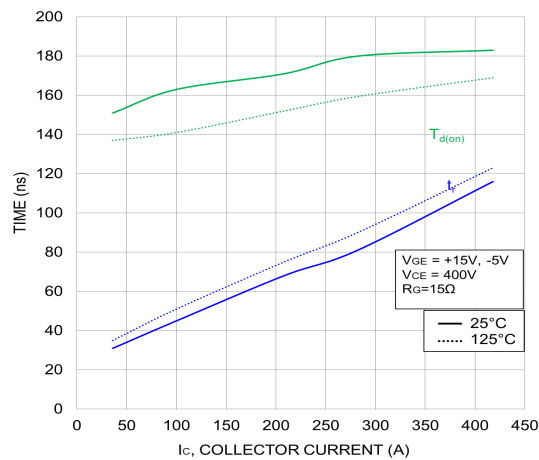

Figure 26. Typical Switching Time Tdon vs. IC

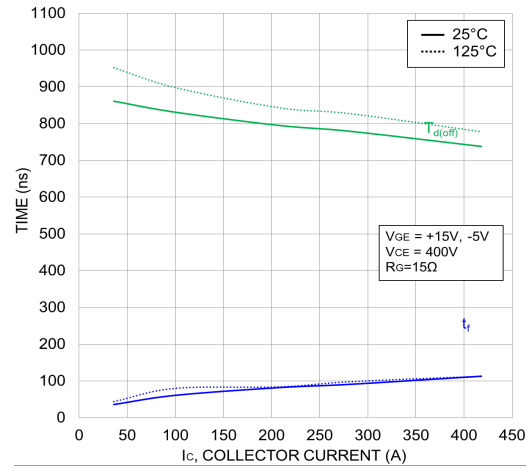

Figure 27. Typical Switching Time Tdoff vs. IC

NXH450N65L4Q2F2

TYPICAL CHARACTERISTICS – Q1/Q4 IGBT COMUTATES D5/D6 DIODE

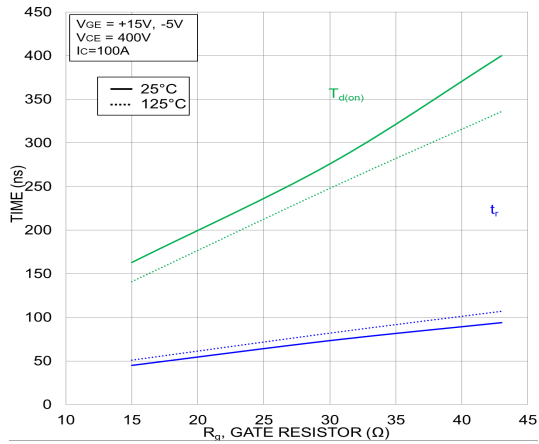

Figure 28. Typical Switching Time Tdon vs. R_G

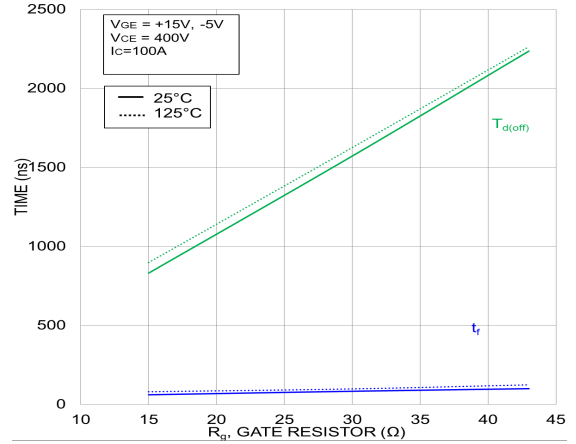

Figure 29. Typical Switching Time Tdoff vs. R_G

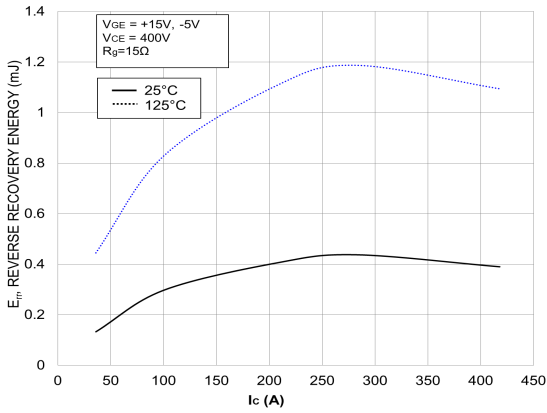

Figure 30. Typical Reverse Recovery Energy vs. I_C

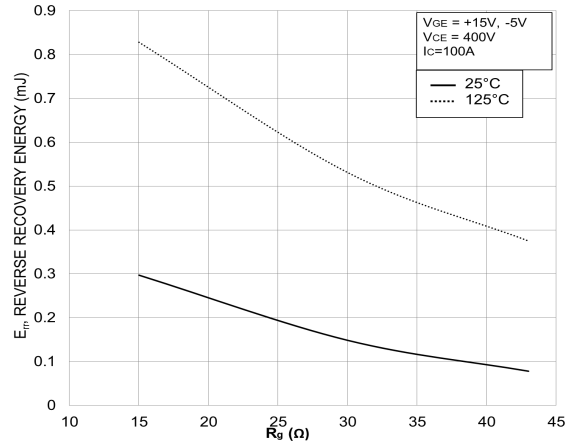

Figure 31. Typical Reverse Recovery Energy vs. R_G

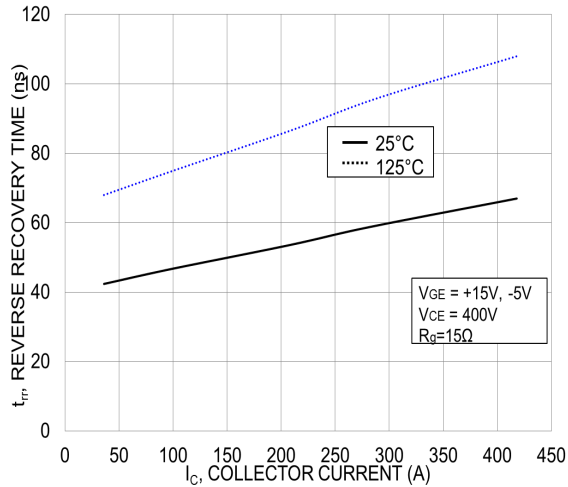

Figure 32. Typical Reverse Recovery Time vs. I_C

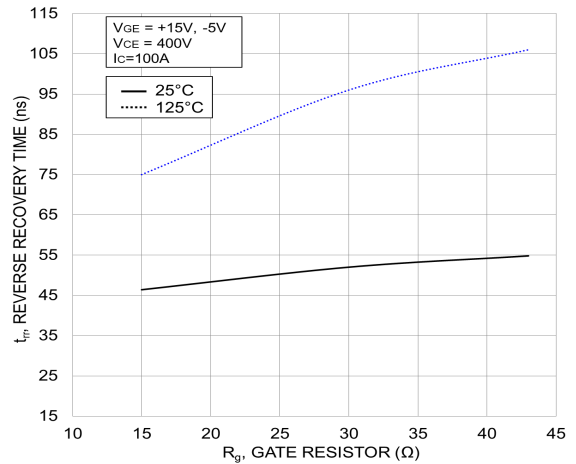

Figure 33. Typical Reverse Recovery Time vs. R_G

NXH450N65L4Q2F2

TYPICAL CHARACTERISTICS – Q1/Q4 IGBT COMUTATES D5/D6 DIODE

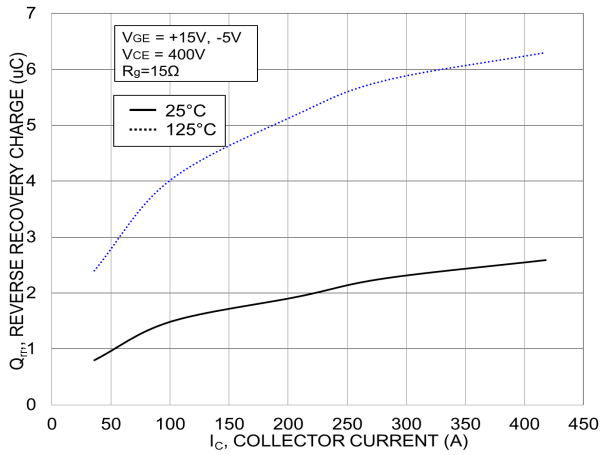

Figure 34. Typical Reverse Recovery Charge vs. IC

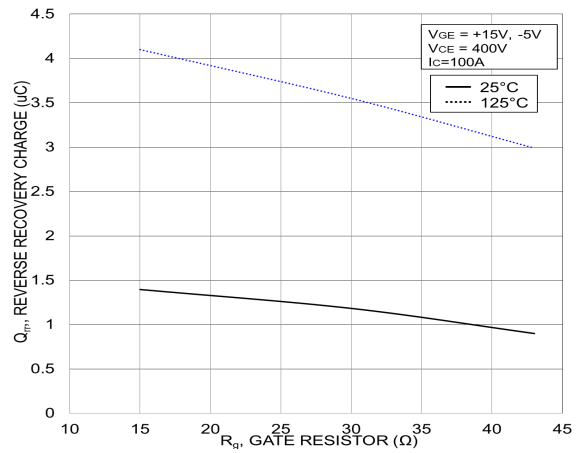

Figure 35. Typical Reverse Recovery Charge vs. R_G

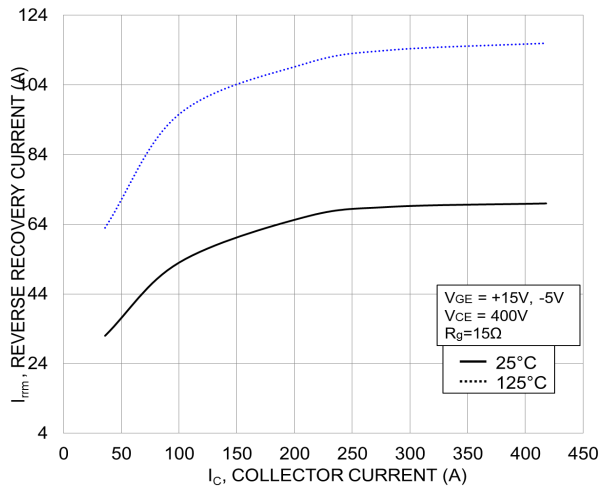

Figure 36. Typical Reverse Recovery Current vs. IC

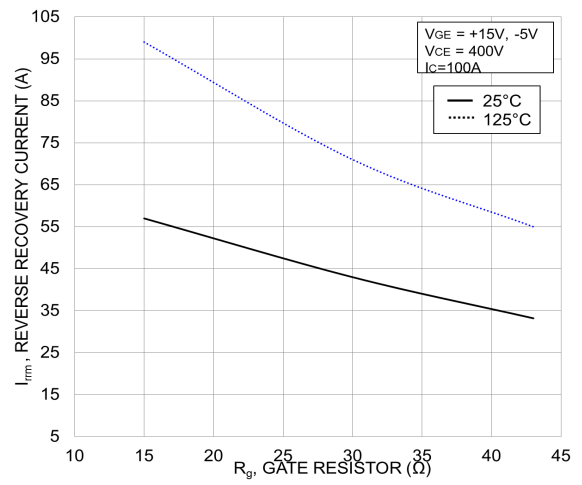

Figure 37. Typical Reverse Recovery Current vs. R_G

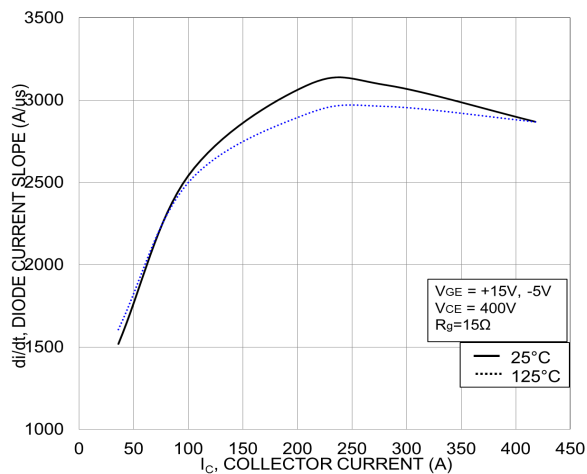

Figure 38. Typical di/dt vs. IC

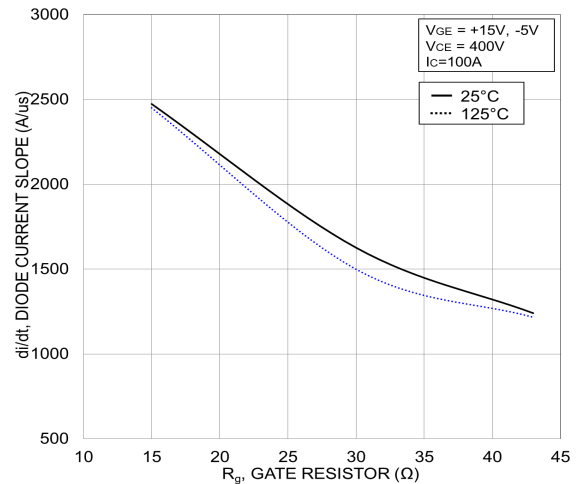

Figure 39. Typical di/dt vs. R_G

NXH450N65L4Q2F2

TYPICAL CHARACTERISTICS – Q2/Q3 IGBT COMUTATES D1/D4 DIODE

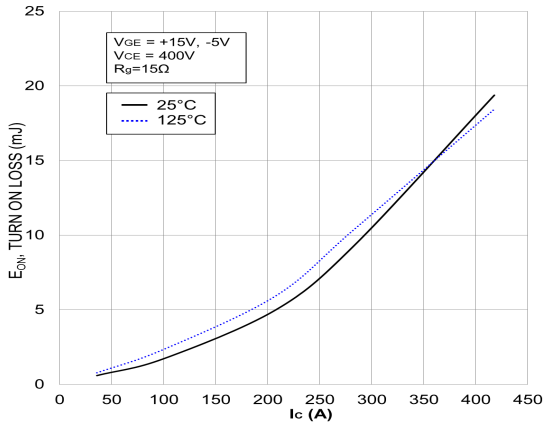

Figure 40. Typical Switching Loss Eon vs. IC

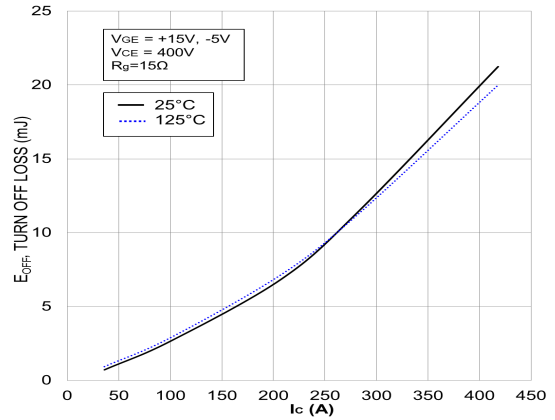

Figure 41. Typical Switching Loss Eoff vs. IC

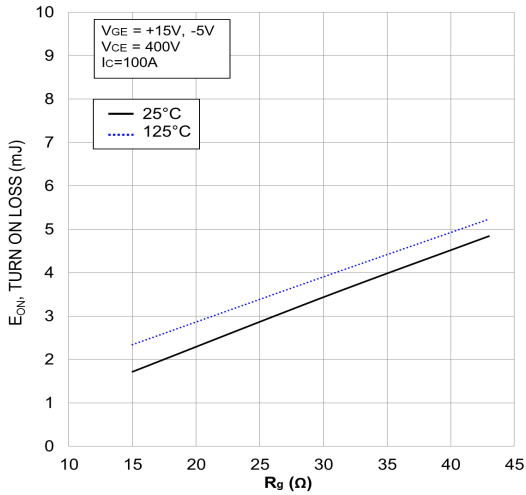

Figure 42. Typical Switching Loss Eon vs. R_G

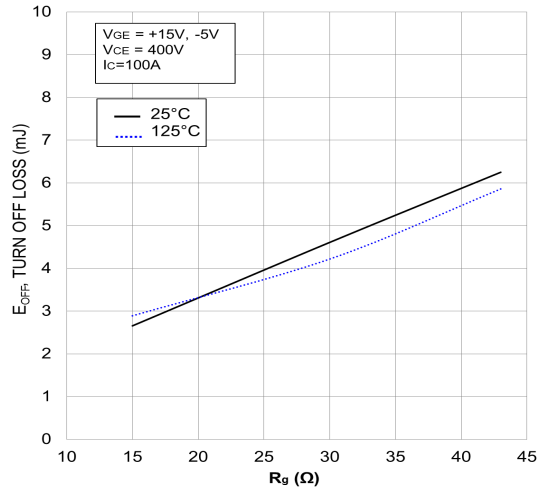

Figure 43. Typical Switching Loss Eoff vs. R_G

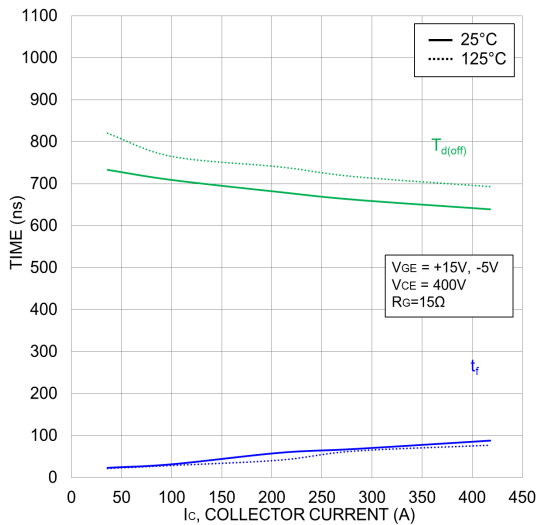

Figure 44. Typical Turn-On Switching Time vs. IC

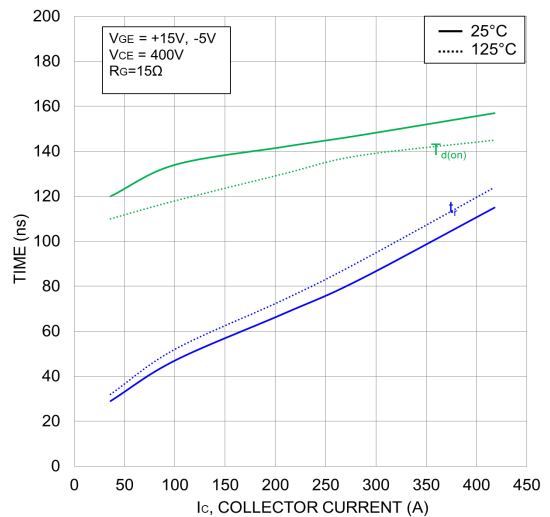

Figure 45. Typical Turn-Off Switching Time vs. IC

NXH450N65L4Q2F2

TYPICAL CHARACTERISTICS – Q2/Q3 IGBT COMUTATES D1/D4 DIODE

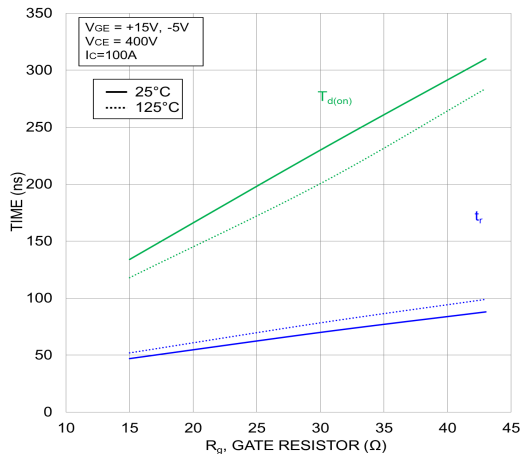

Figure 46. Typical Turn-On Switching Time vs. R_g

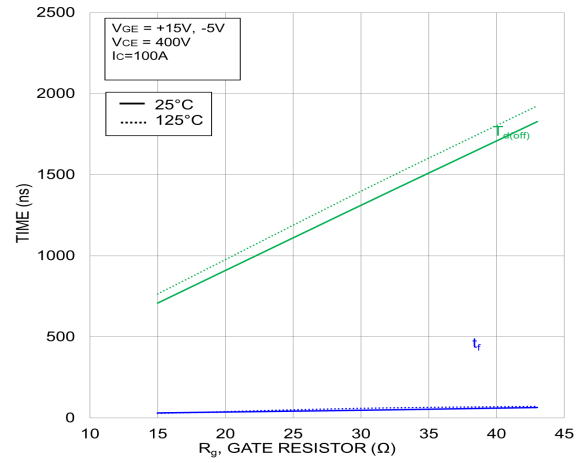

Figure 47. Typical Turn-Off Switching Time vs. R_g

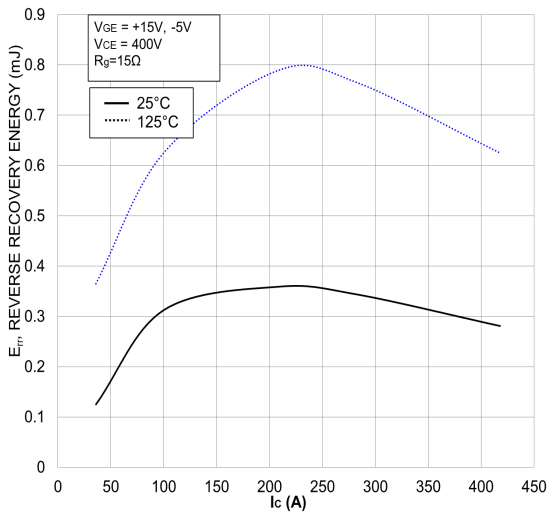

Figure 48. Typical Reverse Recovery Energy Loss vs. I_C

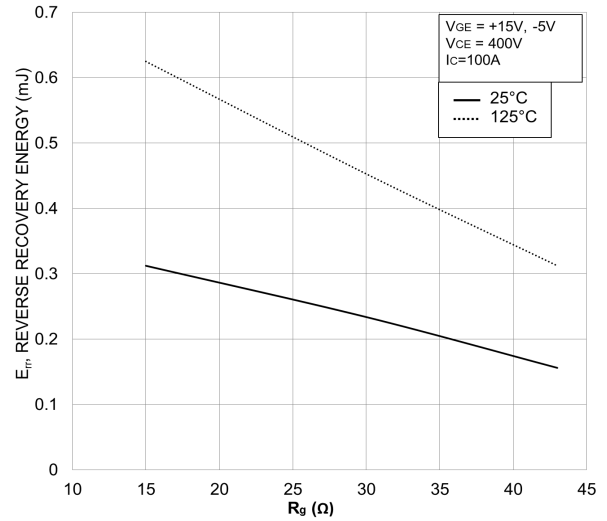

Figure 49. Typical Reverse Recovery Energy Loss vs. R_g

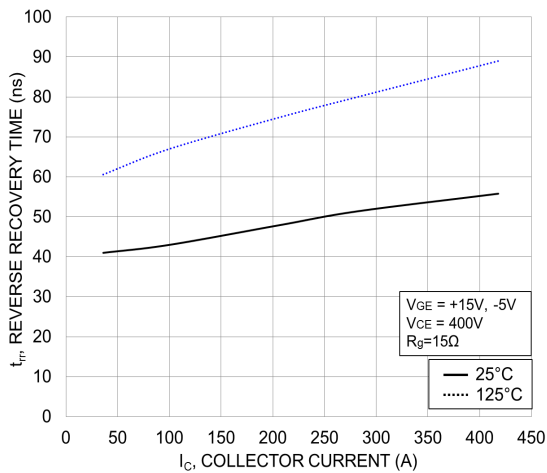

Figure 50. Typical Reverse Recovery Time vs. I_C

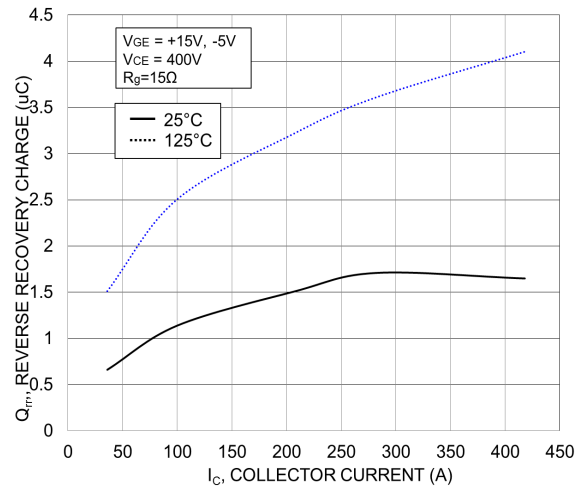

Figure 51. Typical Reverse Recovery Charge vs. I_C

NXH450N65L4Q2F2

TYPICAL CHARACTERISTICS – Q2/Q3 IGBT COMUTATES D1/D4 DIODE

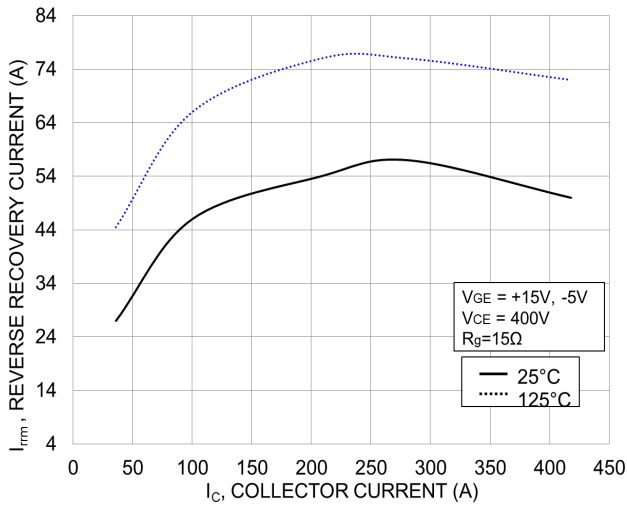

Figure 52. Typical Reverse Recovery Current vs. I_C

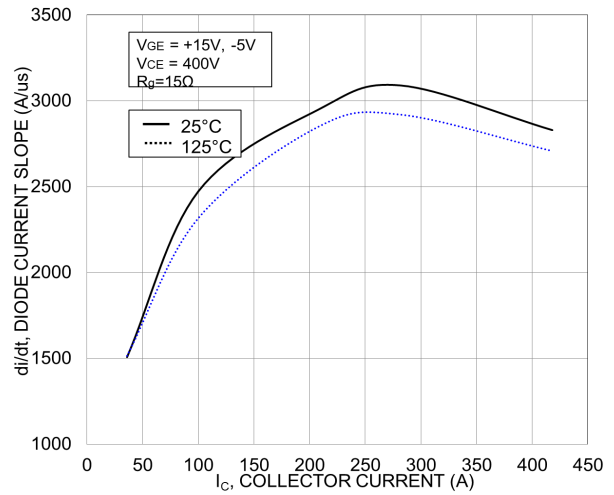

Figure 53. Typical di/dt Current Slope vs. I_C

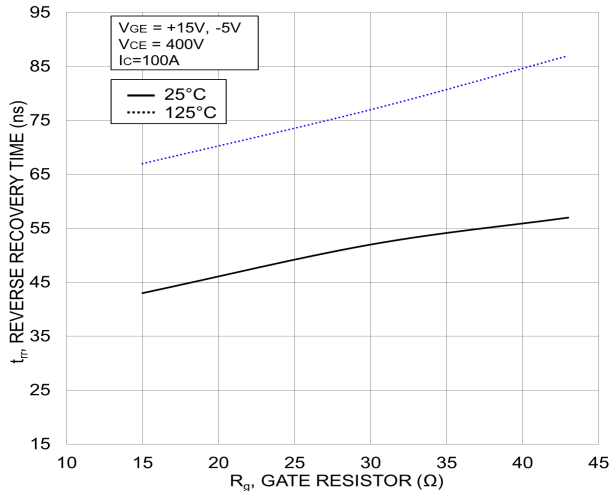

Figure 54. Typical Reverse Recovery Time vs. R_G

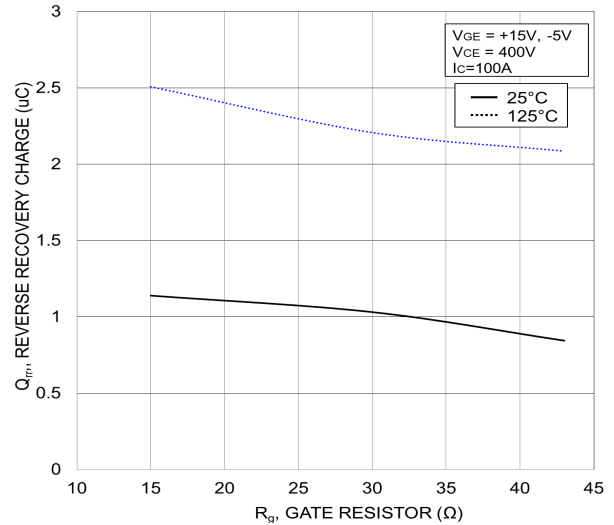

Figure 55. Typical Reverse Recovery Charge vs. R_G

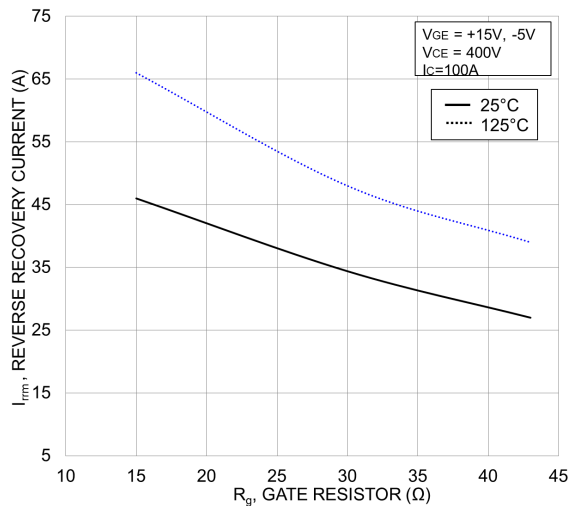

Figure 56. Typical Reverse Recovery Peak Current vs. R_G

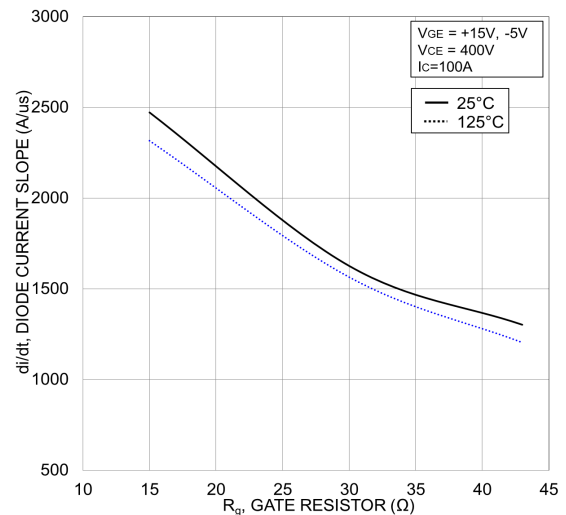

Figure 57. Typical di/dt vs. R_G

MECHANICAL CASE OUTLINE PACKAGE DIMENSIONS



PIM40, 107.2x47
CASE 180BE
ISSUE C

DATE 27 JUL 2022

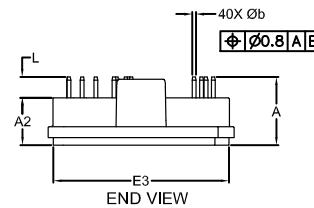
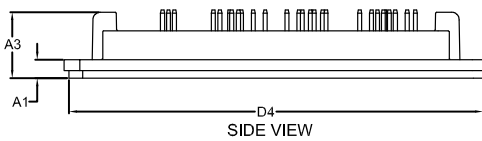
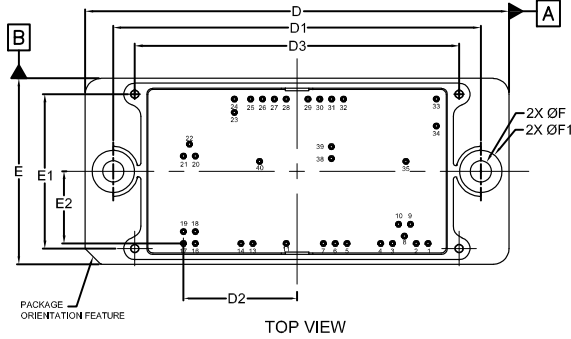
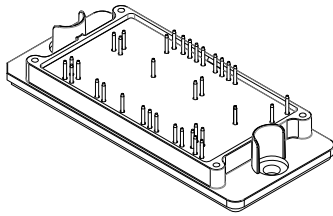

MILLIMETERS			
DIM	MIN.	NOM.	MAX.
A	16.63	17.23	17.83
A1	4.50	4.70	4.90
A2	11.60	12.00	12.40
A3	16.40	16.70	17.00
b	0.95	1.00	1.05
D	106.80	107.20	107.60
D1	92.90	93.00	93.10
D2	28.40	28.70	29.00
D3	81.80	82.00	82.20
D4	104.35	104.75	105.15
E	46.60	47.00	47.40
E1	38.80	39.00	39.20
E2	17.95	18.25	18.55
E3	44.30	44.40	44.50
F	5.40	5.50	5.60
F1	10.70 REF		
L	5.03	5.23	5.43

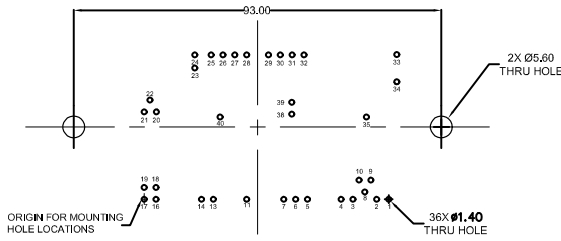

For additional information on our Pb-Free strategy and soldering details, please download the On Semiconductor Soldering and Mounting Techniques Reference Manual, SOLDERRM/D.

GENERIC MARKING DIAGRAM*

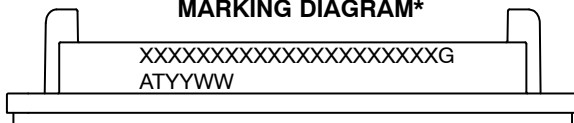

XXXXX = Specific Device Code
G = Pb-Free Package
AT = Assembly & Test Site Code
YYWW = Year and Work Week Code

*This information is generic. Please refer to device data sheet for actual part marking. Pb-Free indicator, "G" or microdot "▪", may or may not be present. Some products may not follow the Generic Marking.

NOTE 4

PIN	PIN POSITION		PIN	PIN POSITION	
	X	Y		X	Y
1	61.85	0.0	21	0.0	22.1
2	58.85	0.0	22	1.5	25.1
3	52.85	0.0	23	12.85	33.15
4	49.85	0.0	24	12.85	36.5
5	41.35	0.0	25	16.95	36.5
6	38.35	0.0	26	19.95	36.5
7	35.35	0.0	27	22.95	36.5
8	55.85	1.85	28	25.95	36.5
9	57.35	4.85	29	31.45	36.5
10	54.35	4.85	30	34.45	36.5
11	25.95	0.0	31	37.45	36.5
13	17.5	0.0	32	40.45	36.5
14	14.5	0.0	33	63.9	36.55
16	3.0	0.0	34	63.9	29.7
17	0.0	0.0	35	56.2	20.75
18	3.0	3.0	38	37.4	21.5
19	0.0	3.0	39	37.4	24.5
20	3.0	22.1	40	19.2	20.75

NOTES:

1. DIMENSIONING AND TOLERANCING PER ASME 7 14.5M, 2009.
2. CONTROLLING DIMENSION: MILLIMETERS
3. DIMENSIONS b APPLY TO THE PLATED TERMINALS AND ARE MEASURED WHERE THE PIN EXITS THE PACKAGE BODY.
4. POSITION OF THE CENTER OF THE TERMINALS IS DETERMINED FROM PIN 17. POSITIONAL TOLERANCE, AS NOTED IN THE DRAWING, APPLIES TO EACH TERMINAL.

DOCUMENT NUMBER:	98AON06409H	Electronic versions are uncontrolled except when accessed directly from the Document Repository. Printed versions are uncontrolled except when stamped "CONTROLLED COPY" in red.
DESCRIPTION:	PIM40, 107.2x47	PAGE 1 OF 1

onsemi and ONSEMI are trademarks of Semiconductor Components Industries, LLC dba onsemi or its subsidiaries in the United States and/or other countries. onsemi reserves the right to make changes without further notice to any products herein. onsemi makes no warranty, representation or guarantee regarding the suitability of its products for any particular purpose, nor does onsemi assume any liability arising out of the application or use of any product or circuit, and specifically disclaims any and all liability, including without limitation special, consequential or incidental damages. onsemi does not convey any license under its patent rights nor the rights of others.

MECHANICAL CASE OUTLINE

PACKAGE DIMENSIONS

ON Semiconductor®



PIM36, 93x47 (PRESSFIT) CASE 180CD ISSUE O

DATE 24 APR 2020

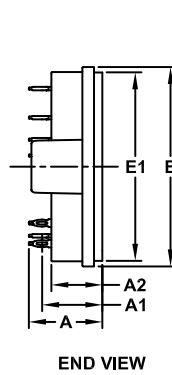
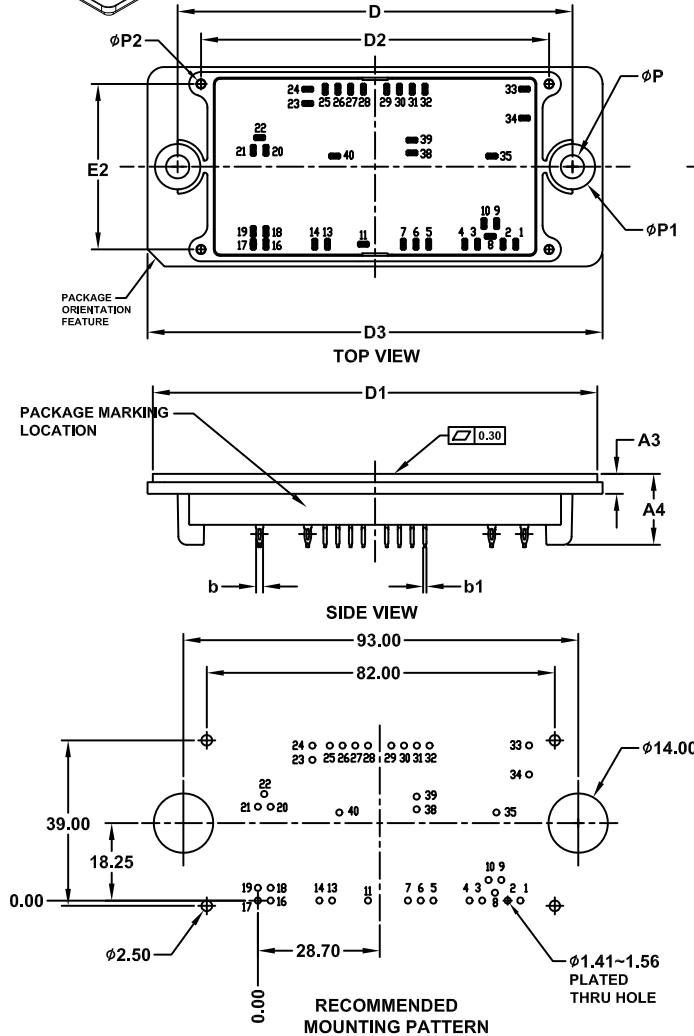
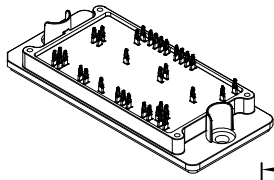

DIM	MILLIMETERS		
	MIN.	NOM.	MAX.
A	16.90	17.30	17.70
A1	13.97	14.18	14.39
A2	11.70	12.00	12.30
A3	4.40	4.70	5.00
A4	16.40	16.70	17.00
b	1.61	1.66	1.71
b1	0.75	0.80	0.85
D	92.90	93.00	93.10
D1	104.45	104.75	105.05
D2	81.80	82.00	82.20
D3	106.90	107.20	107.50
E	46.70	47.00	47.30
E1	44.10	44.40	44.70
E2	38.80	39.00	39.20
P	5.40	5.50	5.60
P1	10.60	10.70	10.80
P2	1.80	2.00	2.20

NOTE 4

PIN	PIN POSITION		PIN	PIN POSITION	
	X	Y		X	Y
1	61.85	0.00	21	0.00	22.10
2	58.85	0.00	22	1.50	25.10
3	52.85	0.00	23	12.85	33.15
4	49.85	0.00	24	12.85	36.50
5	41.35	0.00	25	16.95	36.50
6	38.35	0.00	26	19.95	36.50
7	35.35	0.00	27	22.95	36.50
8	55.85	1.85	28	25.95	36.50
9	57.35	4.85	29	31.45	36.50
10	54.35	4.85	30	34.45	36.50
11	25.95	0.00	31	37.45	36.50
13	17.50	0.00	32	40.45	36.50
14	14.50	0.00	33	63.90	36.55
16	3.00	0.00	34	63.90	29.70
17	0.00	0.00	35	56.20	20.75
18	3.00	3.00	38	37.40	21.50
19	0.00	3.00	39	37.40	24.50
20	3.00	22.10	40	19.20	20.75

NOTES:

1. DIMENSIONING AND TOLERANCING PER ASME Y14.5M, 2009
2. CONTROLLING DIMENSION : MILLIMETERS
3. DIMENSIONS b AND b1 APPLY TO THE PLATED TERMINALS AND ARE MEASURED AT DIMENSION A1
4. PIN POSITION TOLERANCE IS ± 0.4mm
5. PACKAGE MARKING IS LOCATED AS SHOWN ON THE SIDE OPPOSITE THE PACKAGE ORIENTATION FEATURES

GENERIC MARKING DIAGRAM*

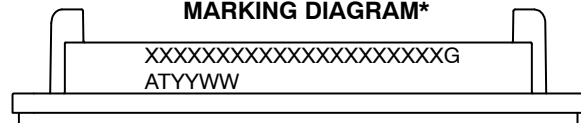

XXXXXX = Specific Device Code
 G = Pb-Free Package
 AT = Assembly & Test Site Code
 YYWW = Year and Work Week Code

*This information is generic. Please refer to device data sheet for actual part marking. Pb-Free indicator, "G" or microdot "▪", may or may not be present. Some products may not follow the Generic Marking.

DOCUMENT NUMBER:	98AON20719H	Electronic versions are uncontrolled except when accessed directly from the Document Repository. Printed versions are uncontrolled except when stamped "CONTROLLED COPY" in red.
DESCRIPTION:	PIM36 93X47 (PRESS FIT)	PAGE 1 OF 1

ON Semiconductor and ON are trademarks of Semiconductor Components Industries, LLC dba ON Semiconductor or its subsidiaries in the United States and/or other countries. ON Semiconductor reserves the right to make changes without further notice to any products herein. ON Semiconductor makes no warranty, representation or guarantee regarding the suitability of its products for any particular purpose, nor does ON Semiconductor assume any liability arising out of the application or use of any product or circuit, and specifically disclaims any and all liability, including without limitation special, consequential or incidental damages. ON Semiconductor does not convey any license under its patent rights nor the rights of others.

onsemi, **Onsemi**, and other names, marks, and brands are registered and/or common law trademarks of Semiconductor Components Industries, LLC dba "**onsemi**" or its affiliates and/or subsidiaries in the United States and/or other countries. **onsemi** owns the rights to a number of patents, trademarks, copyrights, trade secrets, and other intellectual property. A listing of **onsemi**'s product/patent coverage may be accessed at www.onsemi.com/site/pdf/Patent-Marking.pdf. **onsemi** reserves the right to make changes at any time to any products or information herein, without notice. The information herein is provided "as-is" and **onsemi** makes no warranty, representation or guarantee regarding the accuracy of the information, product features, availability, functionality, or suitability of its products for any particular purpose, nor does **onsemi** assume any liability arising out of the application or use of any product or circuit, and specifically disclaims any and all liability, including without limitation special, consequential or incidental damages. Buyer is responsible for its products and applications using **onsemi** products, including compliance with all laws, regulations and safety requirements or standards, regardless of any support or applications information provided by **onsemi**. "Typical" parameters which may be provided in **onsemi** data sheets and/or specifications can and do vary in different applications and actual performance may vary over time. All operating parameters, including "Typicals" must be validated for each customer application by customer's technical experts. **onsemi** does not convey any license under any of its intellectual property rights nor the rights of others. **onsemi** products are not designed, intended, or authorized for use as a critical component in life support systems or any FDA Class 3 medical devices or medical devices with a same or similar classification in a foreign jurisdiction or any devices intended for implantation in the human body. Should Buyer purchase or use **onsemi** products for any such unintended or unauthorized application, Buyer shall indemnify and hold **onsemi** and its officers, employees, subsidiaries, affiliates, and distributors harmless against all claims, costs, damages, and expenses, and reasonable attorney fees arising out of, directly or indirectly, any claim of personal injury or death associated with such unintended or unauthorized use, even if such claim alleges that **onsemi** was negligent regarding the design or manufacture of the part. **onsemi** is an Equal Opportunity/Affirmative Action Employer. This literature is subject to all applicable copyright laws and is not for resale in any manner.

ADDITIONAL INFORMATION

TECHNICAL PUBLICATIONS:

Technical Library: www.onsemi.com/design/resources/technical-documentation
onsemi Website: www.onsemi.com

ONLINE SUPPORT: www.onsemi.com/support

For additional information, please contact your local Sales Representative at www.onsemi.com/support/sales