

ASPM16 Series for Exciter Motor Application Automotive 650 V 75 A Smart Power Module

NFVF97565L1ZT1

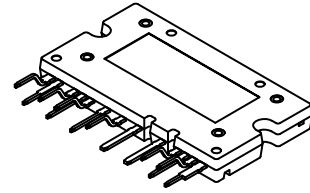

ASPMCA-A16
 CASE MODGH

General Description

NFVF97565L1ZT1 is an advanced automotive smart power module providing a fully-featured, high-performance full bridge inverter output stage for Exciter Motor Application.

Features

- 650 V – 75 A Full Bridge Inverter
- 13 pin Automotive Smart Power Module
- AQG324 Qualified and PPAP Capable
- Low-Loss, Short-Circuit Rated IGBTs
- Very Low Thermal Resistance using AlN DBC Substrate
- Thermistor
- UL Certified No. E209204 (UL1557)
- Single In Line Package
- Isolation Rating: 2500 V_{rms} / 1 min
- Comparative Tracking Index (CTI) = 600
- Pb-Free and RoHS Compliant

Applications

- Exciter Motor Application

Integrated Power Functions

- 650 V – 75 A IGBT Full Bridge Inverter for DC / AC Power Conversion (Please Refer to Figure 2)

MARKING DIAGRAM

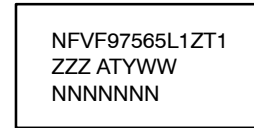

NFVF97565L1ZT1 = Specific Device Code
 ZZZ = Lot ID
 AT = Assembly & Test Location
 Y = Year
 W = Work Week
 NNN = Serial Number

ORDERING INFORMATION

See detailed ordering and shipping information on page 6 of this data sheet.

NFVF97565L1ZT1

Pin Configuration

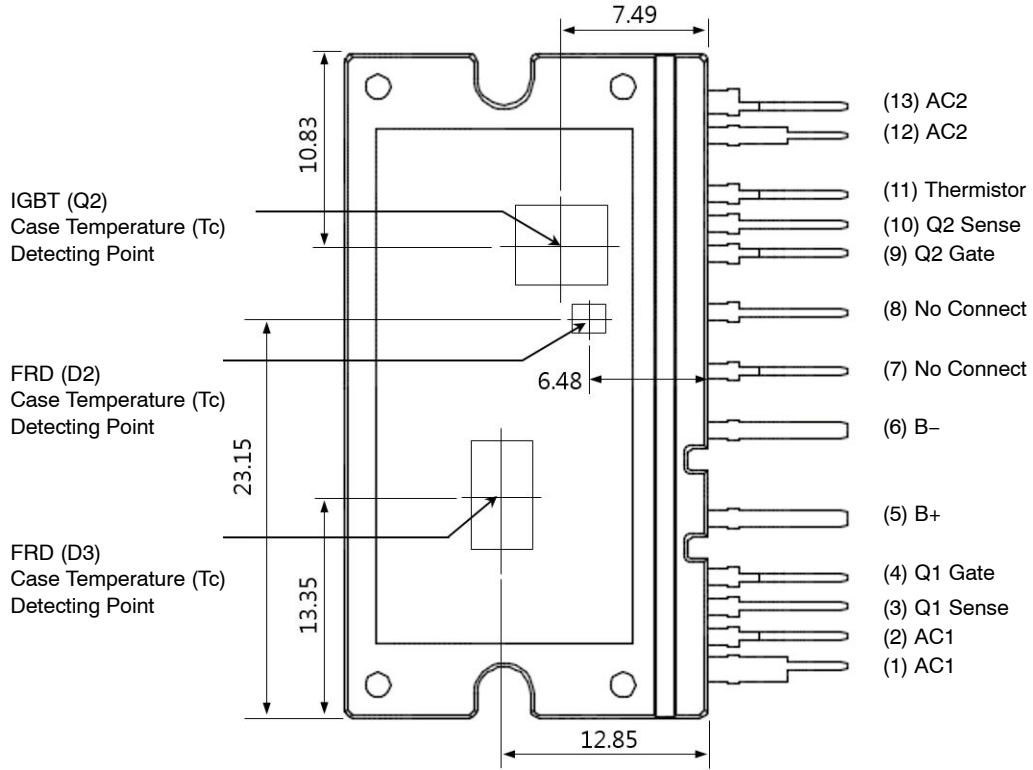

Figure 1. Bottom View

PIN DESCRIPTIONS

Pin No.	Pin Name	Pin Description
1	AC1	AC1
2	AC1	AC1
3	Q ₁ Sense	Sense of Q ₁ IGBT
4	Q ₁ Gate	Gate of Q ₁ IGBT
5	B+	Positive Battery Input
6	B-	Negative Battery Input
7	No Connect	
8	No Connect	
9	Q ₂ Gate	Gate of Q ₂ IGBT
10	Q ₂ Sense	Sense of Q ₂ IGBT
11	Thermistor	Thermistor
12	AC2	AC2
13	AC2	AC2

NFVF97565L1ZT1

Internal Equivalent Circuit and Input/Output Pins

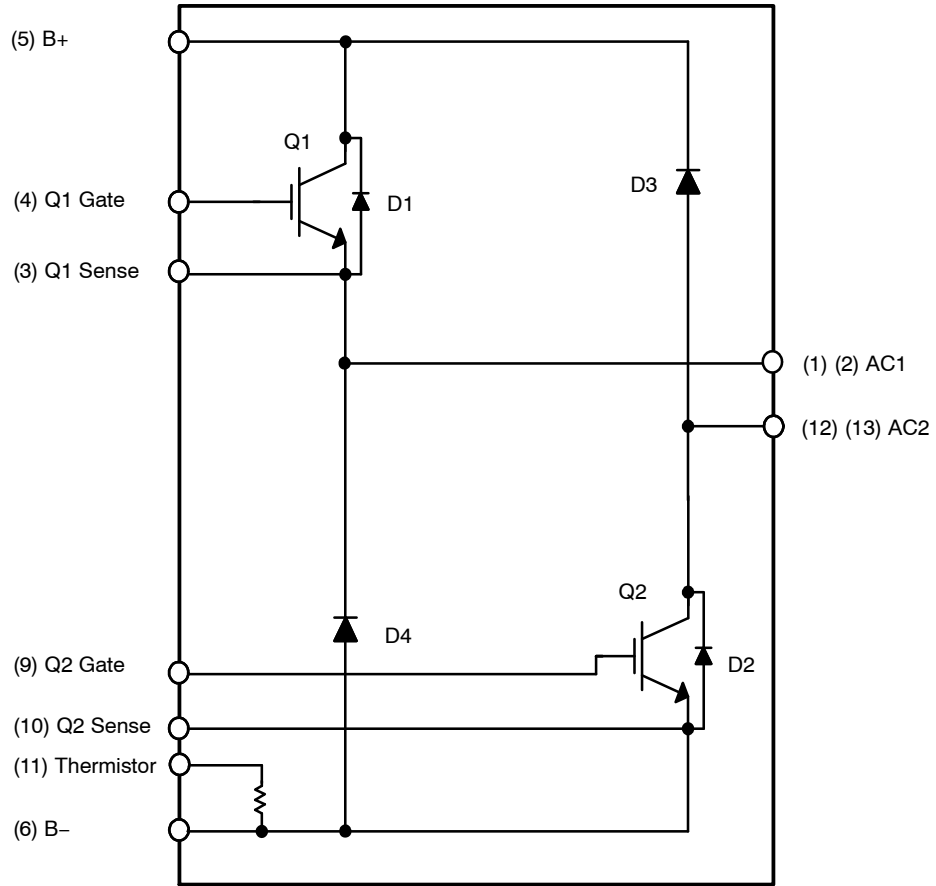

Figure 2. Internal Block Diagram

NFVF97565L1ZT1

ABSOLUTE MAXIMUM RATINGS (T_C = 25°C, Unless Otherwise Specified)

Symbol	Parameter	Conditions	Rating	Unit
IGBT AND FRD PART				
V _{CES}	IGBT Collector – Emitter Voltage		650	V
I _C	Each IGBT Collector Current	T _C = 25°C, T _J ≤ 175°C (Note 1)	150	A
	Each IGBT Collector Current	T _C = 100°C, T _J ≤ 175°C (Note 1)	75	A
I _{CM}	Each IGBT Pulsed Collector Current	T _J ≤ 175°C, Under 1 ms Pulse Width (Note 2)	225	A
V _{RRM}	FRD Repetitive Reverse Voltage		650	V
I _F (D3, D4)	Each FRD Forward Current	T _C = 25°C, T _J ≤ 175°C (Note 1)	150	A
	Each FRD Forward Current	T _C = 100°C, T _J ≤ 175°C (Note 1)	75	A
I _{FM} (D3, D4)	Each FRD Pulsed Forward Current	T _J ≤ 175°C, Under 1ms Pulse Width (Note 2)	225	A
I _F (D1, D2)	Each FRD Forward Current	T _C = 25°C, T _J ≤ 175°C (Note 1)	30	A
	Each FRD Forward Current	T _C = 100°C, T _J ≤ 175°C (Note 1)	15	A
I _{FM} (D1, D2)	Each FRD Pulsed Forward Current	T _J ≤ 175°C, Under 1ms Pulse Width (Note 2)	45	A
I ² t	I ² t for FRD (D3, D4) Current square time	Value Corresponding to 1 cycle of half wave 60 Hz, surge on-state current, T _J = 85°C (Note 1)	200	A ² s
	I ² t for FRD (D1, D2) Current square time		30	A ² s
V _{GE}	Transient Gate–Emitter Voltage		±20	V
P _C	IGBT Power Dissipation	T _C = 25°C per One Chip (Note 3)	483	W
P _K	FRD (D3, D4) Part Power Dissipation	T _C = 25°C per One Chip (Note 3)	375	W
	FRD (D1, D2) Part Power Dissipation	T _C = 25°C per One Chip (Note 3)	74.6	W
T _J	Operating Junction Temperature		-40~175	°C

TOTAL SYSTEM

T _{SC}	Short Circuit Withstand Time	V _{GE} = 15 V, V _{CE} ≤ 450 V, T _J ≤ 175°C	6	μs
T _{STG}	Storage Temperature		-40~150	°C
T _C	Module Case Operation Temperature	(Note 4)	-40~150	°C
V _{ISO}	Isolation Voltage	60 Hz, Sinusoidal, AC 1 minute, Connection Pins to Heat Sink Plate	2500	V _{rms}

THERMAL RESISTANCE

Symbol	Parameter	Conditions	Min.	Typ.	Max	Unit
R _{th(j-c)Q}	Junction to Case Thermal Resistance (Note 3)	IGBT part	-	-	0.31	°C/W
R _{th(j-c)F}		FWD (D3, D4) Part	-	-	0.40	°C/W
R _{th(j-c)F}		FWD (D1, D2) Part	-	-	2.01	°C/W
L _σ	Package Stray Inductance	B+ to B- (Note 5)		20		nH

Stresses exceeding those listed in the Maximum Ratings table may damage the device. If any of these limits are exceeded, device functionality should not be assumed, damage may occur and reliability may be affected.

NOTES:

- These values had been made an acquisition by the calculation considered to design factor, and Pulse width and period are limited due to junction temperature.
- Repetitive rating : Pulse width limited by max junction temperature.
- For the measurement point of case temperature (T_C), please refer to Figure 1 and Figure 2 of chip location, and case temperature and heat sink temperature are defined on the each surface of base plate and heat sink just under the chips. DBC discoloration and Picker Circle Printing allowed, please refer to application note AN-9190 (Impact of DBC Oxidation on SPM Module Performance).
- T_C is depend on the real operation condition.
- Stray inductance measured per IEC 60747-15.

NFVF97565L1ZT1

ELECTRICAL CHARACTERISTICS

Symbol	Parameter	Conditions	Min.	Typ.	Max.	Unit
IGBT AND FRD PART ($T_J = 25^\circ\text{C}$ as specified)						
$\Delta BV_{CES} / \Delta T_J$	Temperature Coefficient of Break-down Voltage	$V_{GE} = 0\text{ V}, I_C = 1\text{ mA}$	-	0.6	-	V°C
$V_{CE(SAT)}$ (Q1, Q2)	Collector-Emitter Saturation Voltage	$V_{GE} = 15\text{ V}, I_C = 75\text{ A}, T_J = 25^\circ\text{C}$	1.30	1.55	1.95	V
		$V_{GE} = 15\text{ V}, I_C = 75\text{ A}, T_J = 175^\circ\text{C}$	1.50	1.70	2.25	V
V_F (D3, D4)	FRD Forward Voltage	$I_F = 50\text{ A}, T_J = 25^\circ\text{C}$	-	2.10	2.70	V
		$I_F = 50\text{ A}, T_J = 175^\circ\text{C}$	-	1.90	-	V
V_F (D1, D2)	FRD Forward Voltage	$I_F = 15\text{ A}, T_J = 25^\circ\text{C}$	-	1.80	2.40	V
		$I_F = 15\text{ A}, T_J = 175^\circ\text{C}$	-	1.70	-	V
$V_{GE(TH)}$	Gate-Emitter Threshold Voltage	$V_{GE} = V_{CE}, I_C = 75\text{ mA}, T_J = 25^\circ\text{C}$	4.2	5.25	7.5	V
Q_g	Total Gate Charge	$V_{CE} = 400\text{ V}, V_{GE} = 15\text{ V}, I_C = 75\text{ A}$	-	500	-	nC
Q_{ge}	Gate to Emitter Charge		-	30	-	nC
Q_{gc}	Gate to Collector Charge		-	250	-	nC
C_{ies}	Input Capacitance		$V_{CE} = 30\text{ V}, V_{GE} = 0\text{ V}, f_{sw} = 1\text{ MHz}$	-	6350	-
C_{oes}	Output Capacitance		-	230	-	pF
C_{res}	Reverse Capacitance		-	105	-	pF
R_g	Internal IGBT Gate Resistor	$T_J = 25^\circ\text{C}$	-	1.2	10	Ω
I_{GES}	Gate-Emitter Leakage Current	$V_{CE} = 0\text{ V}, V_{GE} = 20\text{ V}, T_J = 25^\circ\text{C}$	-	-	1000	nA
IGBT	$t_{d(on)}$	IGBT Switching Times and Losses $V_{CE} = 400\text{ V}, V_{GE} = 15\text{ V}, I_C = 75\text{ A}, T_J = 25^\circ\text{C}, R_g = 8\ \Omega$ Inductive Load See Figure 13	-	130	-	ns
	t_r		-	70	-	ns
	E_{ON}		-	2.5	-	mJ
	$t_{d(OFF)}$		-	500	-	ns
	t_f		-	70	-	ns
	E_{OFF}		-	3.8	-	mJ
IGBT	$t_{d(on)}$	IGBT Switching Times and Losses $V_{CE} = 400\text{ V}, V_{GE} = 15\text{ V}, I_C = 75\text{ A}, T_J = 175^\circ\text{C}, R_g = 8\ \Omega$ Inductive Load See Figure 13	-	150	-	ns
	t_r		-	74	-	μs
	E_{ON}		-	3.7	-	mJ
	$t_{d(OFF)}$		-	575	-	ns
	t_f		-	74	-	ns
	E_{OFF}		-	3.9	-	mJ
FRD	t_{rr}	FRD Switching Times and Losses (D3, D4) $V_{AK} = 400\text{ V}, R_g = 8\ \Omega, I_A = 75\text{ A}, T_J = 25^\circ\text{C}$	-	50	-	ns
	Q_{rr}		-	200	-	nC
	I_{RRM}		-	8	-	A
	E_{rr}		-	150	-	μJ
FRD	t_{rr}	FRD Switching Times and Losses (D3, D4) $V_{AK} = 400\text{ V}, R_g = 8\ \Omega, I_A = 75\text{ A}, T_J = 175^\circ\text{C}$	-	60	-	ns
	Q_{rr}		-	240	-	nC
	I_{RRM}		-	9.6	-	A
	E_{rr}		-	180	-	μJ
I_{CES}	Collector-Emitter Leakage Current	$T_J = 25^\circ\text{C}, V_{CE} = V_{CES}$	-	-	250	μA
I_R	Anode-Cathode Leakage Current	$T_J = 25^\circ\text{C}, V_{AK} = V_{CES}$	-	-	250	μA

Product parametric performance is indicated in the Electrical Characteristics for the listed test conditions, unless otherwise noted. Product performance may not be indicated by the Electrical Characteristics if operated under different conditions.

NFVF97565L1ZT1

PACKAGE MARKING AND ORDERING INFORMATION

Device Marking	Device	Package	Packing Type	Quantity
NFVF97565L1ZT1	NFVF97565L1ZT1	ASPM16-CAA	Tube	12

TYPICAL PERFORMANCE CHARACTERISTICS

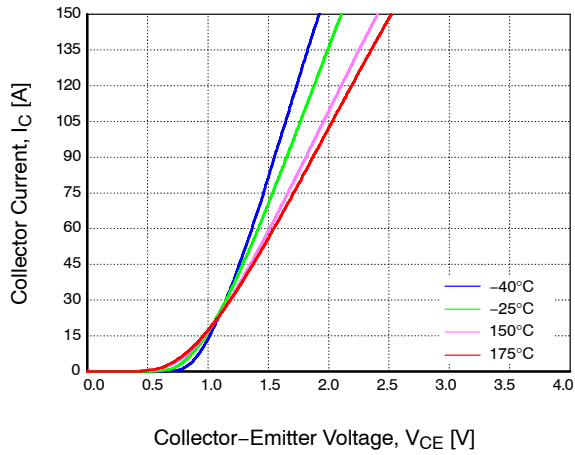

Figure 3. Typical Output Characteristics [Q1 and Q2 IGBT]

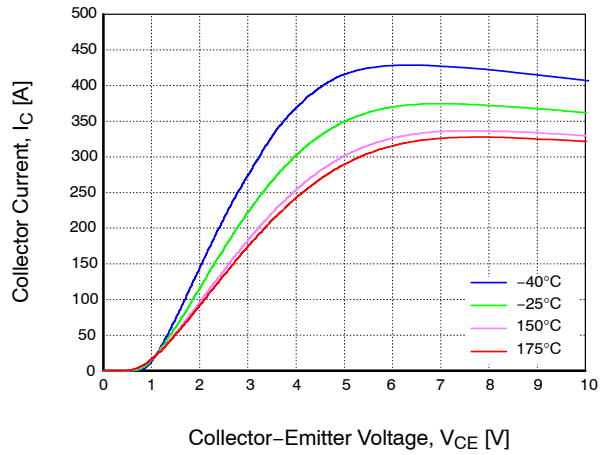

Figure 4. Typical Output Saturation Characteristics [Q1 and Q2 IGBT]

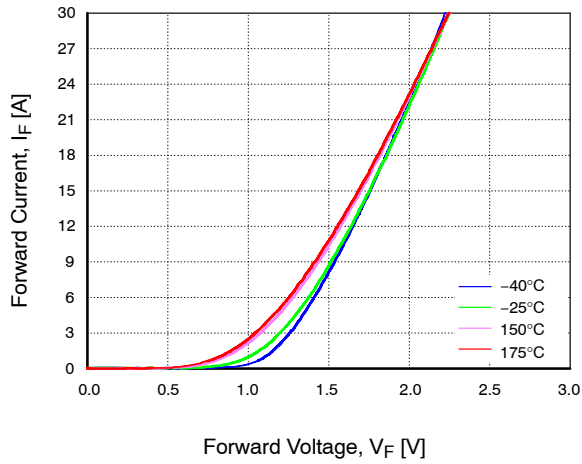

Figure 5. Typical 15 A Diode Forward Voltage

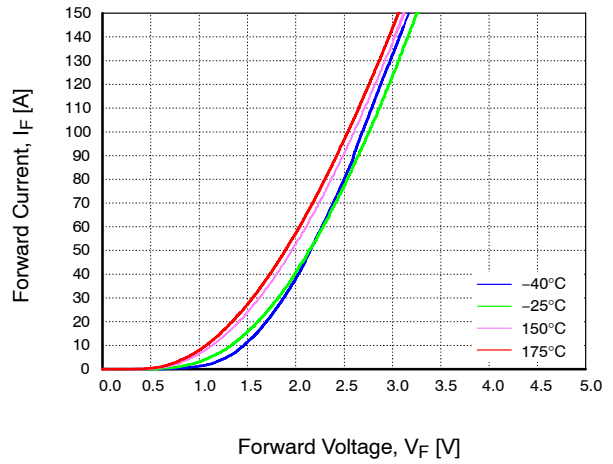

Figure 6. Typical 50 A Diode Forward Voltage

NFVF97565L1ZT1

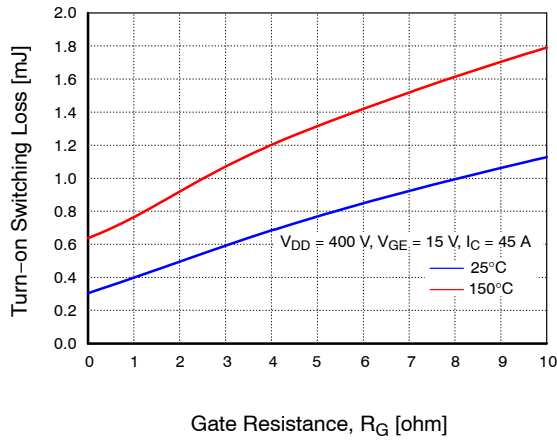

Figure 7. Turn-on Loss vs. Gate Resistance

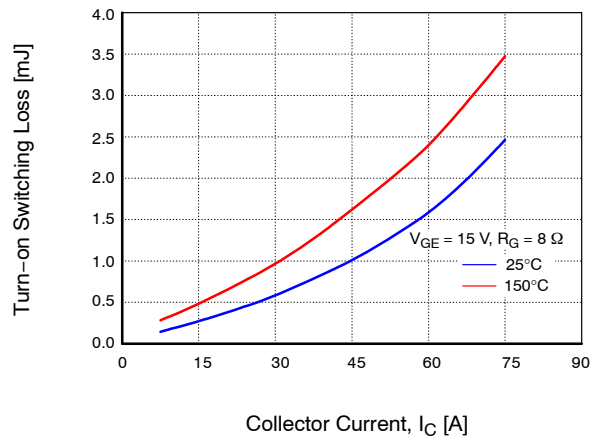

Figure 8. Turn-on Loss vs. Collector Current

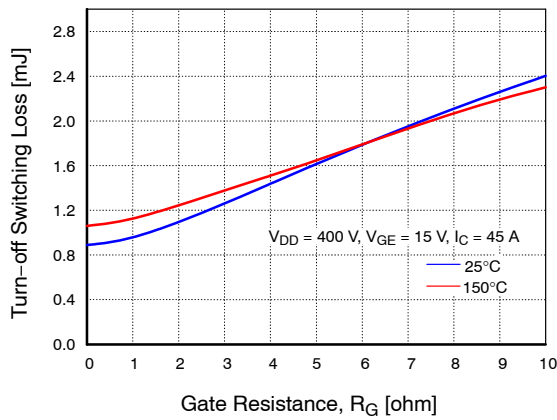

Figure 9. Turn-off Loss vs. Gate Resistance

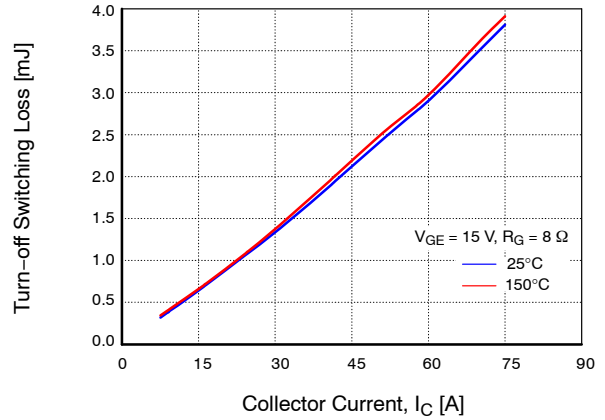

Figure 10. Turn-off Loss vs. Collector Current

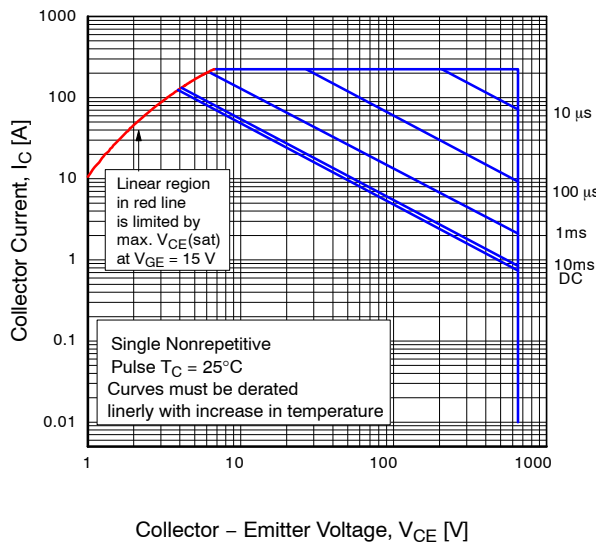

Figure 11. FBSOA Characteristics

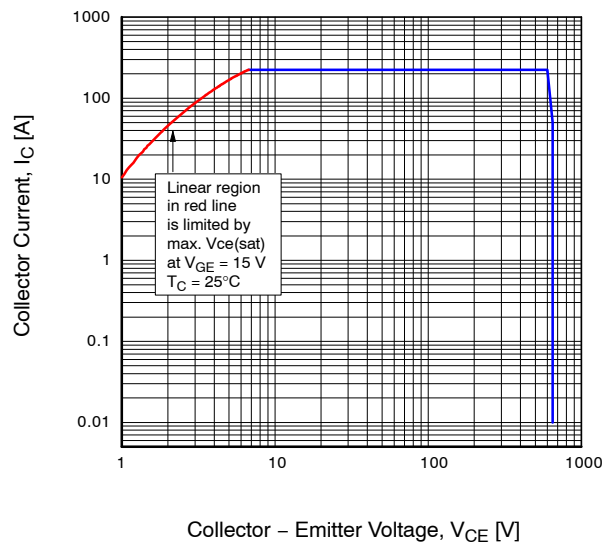

Figure 12. RBSOA Characteristics

NFVF97565L1ZT1

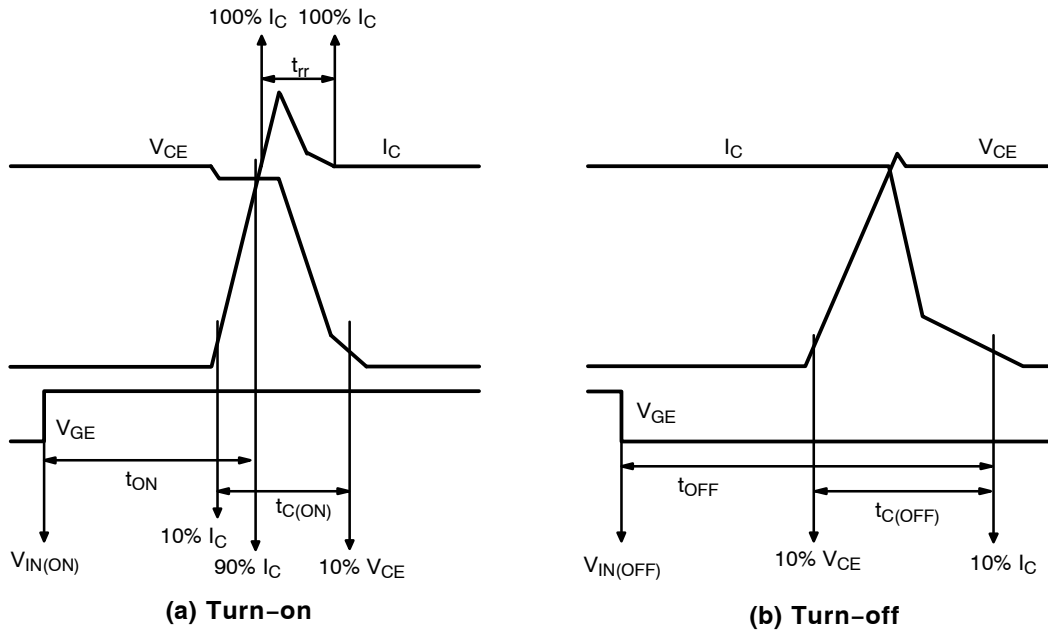

Figure 13. Switching Time Definition

NTC THERMISTOR

Symbol	Parameter	Conditions	Min.	Typ.	Max.	Unit
R _{TH}	Resistance of Thermistor	@T _{TH} = 25°C	-	47	-	kΩ
		@T _{TH} = 100°C	-	2.9	-	kΩ

6. T_{TH} is the temperature of thermistor itself. To know temperature (T_C), please make the experiment considering your application.

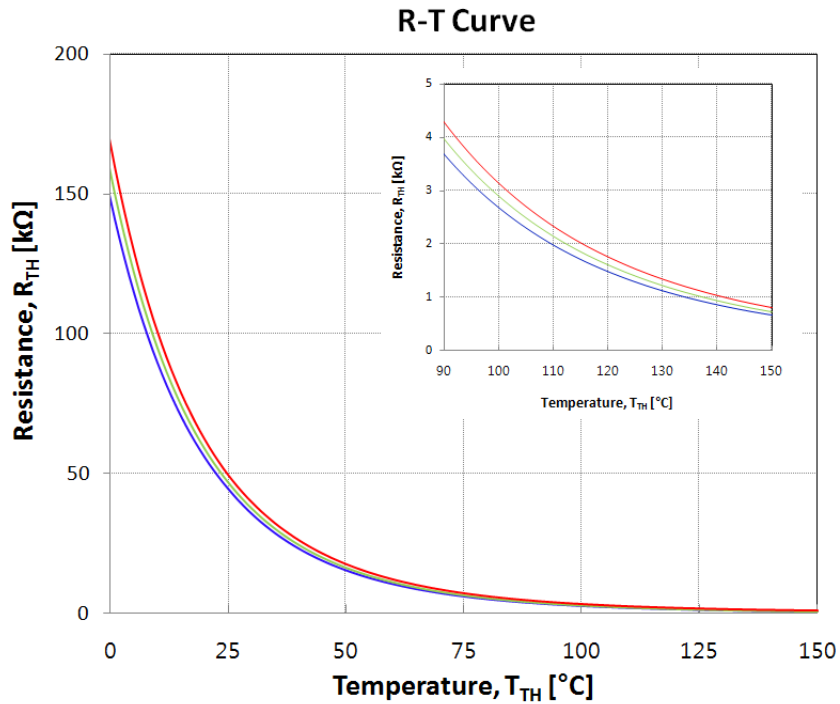

Figure 14. R-T Curve of The Built-in Thermistor

NFVF97565L1ZT1

MECHANICAL CHARACTERISTICS AND RATINGS

Parameter	Conditions	Limits			Unit
		Min.	Typ.	Max.	
Device Flatness	See Figure 15	0	-	150	μm
Weight		-	10	-	g

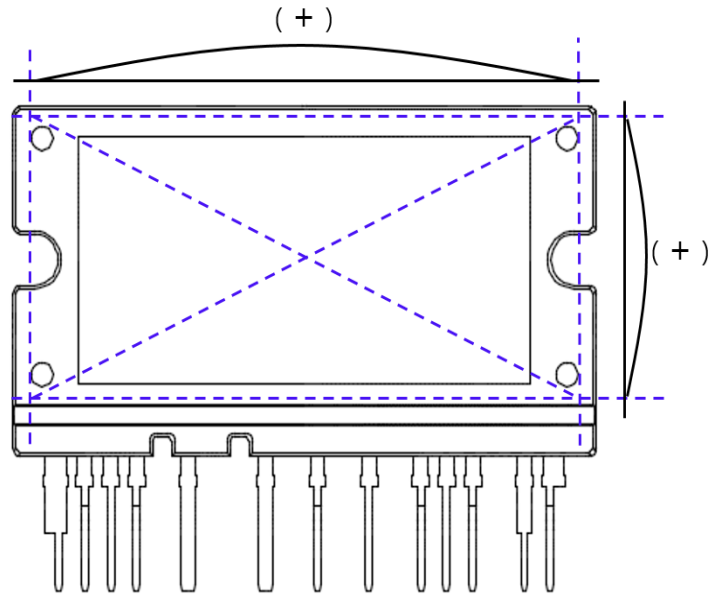

Figure 15. Flatness Measurement Position

MECHANICAL CASE OUTLINE

PACKAGE DIMENSIONS

ON Semiconductor®



ASPMCA-A16 / 13LD, AUTOMOTIVE MODULE CASE MODGH ISSUE B

DATE 03 NOV 2020

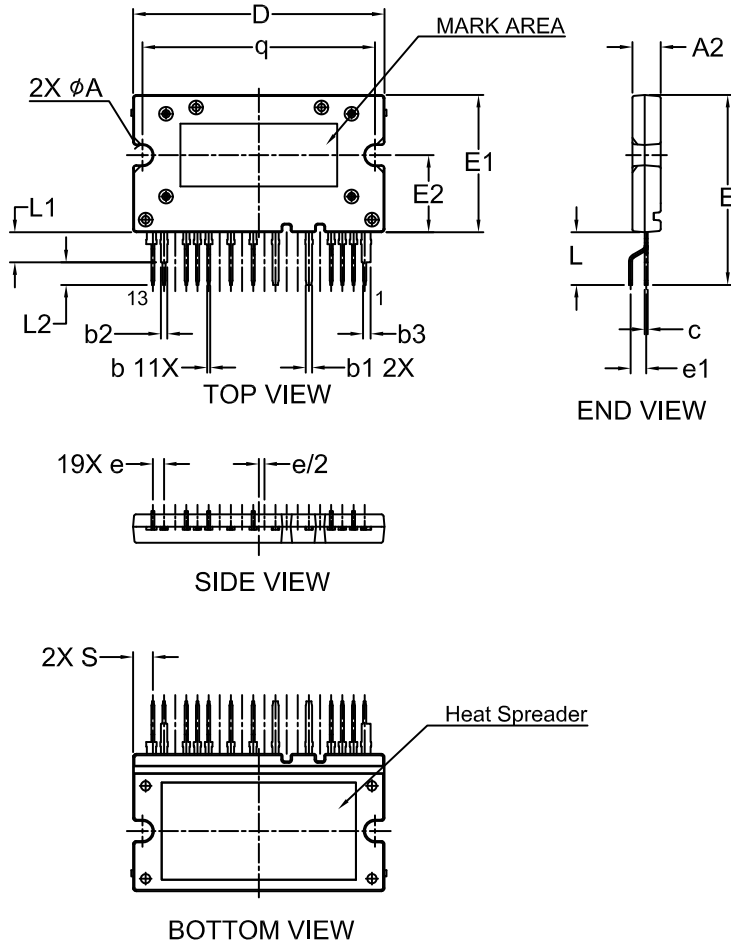
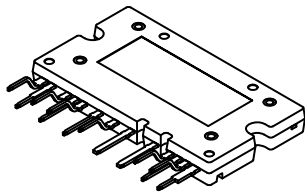

NOTES:

1. DIMENSIONING AND TOLERANCING PER. ASME Y14.5M, 2009.
2. CONTROLLING DIMENSION: MILLIMETERS
3. DIMENSIONS ARE EXCLUSIVE OF BURRS, MOLD FLASH AND TIE BAR EXTRUSIONS.

DIM	MILLIMETERS		
	MIN.	NOM.	MAX.
A2	4.30	4.50	4.70
b	0.45	0.50	0.60
b1	0.95	1.00	1.10
b2	0.95	1.00	1.10
b3	1.15	1.20	1.30
c	0.45	0.50	0.60
D	39.90	40.10	40.30
E	29.80	30.30	30.80
E1	21.70	21.90	22.10
E2	12.10	12.30	12.50
e	1.478	1.778	2.078
e1	2.20	2.50	2.80
L	8.10	8.40	8.70
L1	4.80 REF		
L2	3.30	3.60	3.90
q	36.85	37.10	37.35
S	3.159 REF		
φA	2.95	3.20	3.45

GENERIC MARKING DIAGRAM*

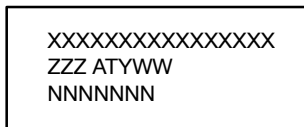

XXXX = Specific Device Code
 ZZZ = Lot ID
 AT = Assembly & Test Location
 Y = Year
 W = Work Week
 NNN = Serial Number

*This information is generic. Please refer to device data sheet for actual part marking. Pb-Free indicator, "G" or microdot "μ", may or may not be present. Some products may not follow the Generic Marking.

DOCUMENT NUMBER:	98AON94739G	Electronic versions are uncontrolled except when accessed directly from the Document Repository. Printed versions are uncontrolled except when stamped "CONTROLLED COPY" in red.
DESCRIPTION:	ASPMCA-A16 / 13LD, AUTOMOTIVE MODULE	PAGE 1 OF 1

ON Semiconductor and are trademarks of Semiconductor Components Industries, LLC dba ON Semiconductor or its subsidiaries in the United States and/or other countries. ON Semiconductor reserves the right to make changes without further notice to any products herein. ON Semiconductor makes no warranty, representation or guarantee regarding the suitability of its products for any particular purpose, nor does ON Semiconductor assume any liability arising out of the application or use of any product or circuit, and specifically disclaims any and all liability, including without limitation special, consequential or incidental damages. ON Semiconductor does not convey any license under its patent rights nor the rights of others.

onsemi, **Onsemi**, and other names, marks, and brands are registered and/or common law trademarks of Semiconductor Components Industries, LLC dba "**onsemi**" or its affiliates and/or subsidiaries in the United States and/or other countries. **onsemi** owns the rights to a number of patents, trademarks, copyrights, trade secrets, and other intellectual property. A listing of **onsemi**'s product/patent coverage may be accessed at www.onsemi.com/site/pdf/Patent-Marking.pdf. **onsemi** reserves the right to make changes at any time to any products or information herein, without notice. The information herein is provided "as-is" and **onsemi** makes no warranty, representation or guarantee regarding the accuracy of the information, product features, availability, functionality, or suitability of its products for any particular purpose, nor does **onsemi** assume any liability arising out of the application or use of any product or circuit, and specifically disclaims any and all liability, including without limitation special, consequential or incidental damages. Buyer is responsible for its products and applications using **onsemi** products, including compliance with all laws, regulations and safety requirements or standards, regardless of any support or applications information provided by **onsemi**. "Typical" parameters which may be provided in **onsemi** data sheets and/or specifications can and do vary in different applications and actual performance may vary over time. All operating parameters, including "Typicals" must be validated for each customer application by customer's technical experts. **onsemi** does not convey any license under any of its intellectual property rights nor the rights of others. **onsemi** products are not designed, intended, or authorized for use as a critical component in life support systems or any FDA Class 3 medical devices or medical devices with a same or similar classification in a foreign jurisdiction or any devices intended for implantation in the human body. Should Buyer purchase or use **onsemi** products for any such unintended or unauthorized application, Buyer shall indemnify and hold **onsemi** and its officers, employees, subsidiaries, affiliates, and distributors harmless against all claims, costs, damages, and expenses, and reasonable attorney fees arising out of, directly or indirectly, any claim of personal injury or death associated with such unintended or unauthorized use, even if such claim alleges that **onsemi** was negligent regarding the design or manufacture of the part. **onsemi** is an Equal Opportunity/Affirmative Action Employer. This literature is subject to all applicable copyright laws and is not for resale in any manner.

ADDITIONAL INFORMATION

TECHNICAL PUBLICATIONS:

Technical Library: www.onsemi.com/design/resources/technical-documentation
onsemi Website: www.onsemi.com

ONLINE SUPPORT: www.onsemi.com/support

For additional information, please contact your local Sales Representative at www.onsemi.com/support/sales