

# NCS2552

## 750 MHz Voltage Feedback Op Amp with Fast Enable Feature

NCS2552 is a 750 MHz voltage feedback monolithic operational amplifier featuring high slew rate and low differential gain and phase error. The voltage feedback architecture allows for a superior bandwidth and low power consumption. This device features an enable pin.

### Features

- -3.0 dB Small Signal BW ( $A_V = +2.0$ ,  $V_O = 0.5 V_{p-p}$ ) 750 MHz Typ
- Slew Rate 1700 V/ $\mu$ s
- Fast Enable Time 5.0 ns
- Supply Current 13 mA
- Input Referred Voltage Noise 5.0 nV/ $\sqrt{\text{Hz}}$
- THD -64 dBc ( $f = 5.0$  MHz,  $V_O = 2.0 V_{p-p}$ )
- Output Current 100 mA
- Pin Compatible with EL5157, AD8057
- This is a Pb-Free Device

### Applications

- Line Drivers
- Radar/Communication Receivers

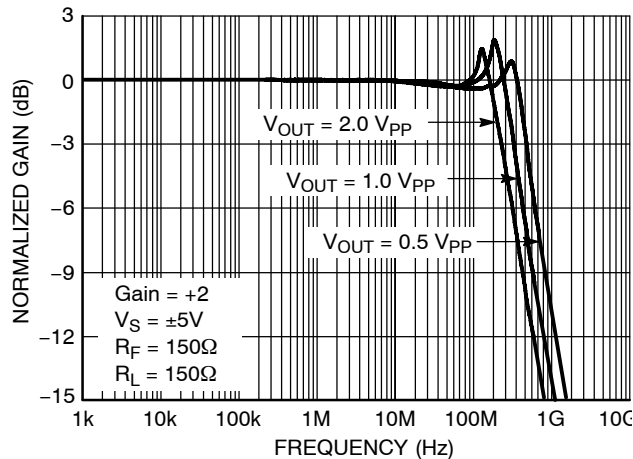

**Figure 1. Frequency Response:**  
Gain (dB) vs. Frequency  $A_V = +2.0$



ON Semiconductor®

<http://onsemi.com>

### MARKING DIAGRAM

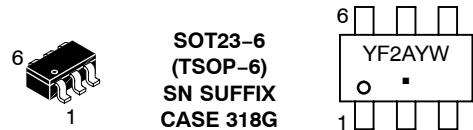

YF2, N2552 = NCS2552  
 A = Assembly Location  
 Y = Year  
 W = Work Week  
 ■ = Pb-Free Package

### SOT23-6 PINOUT

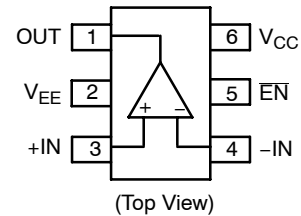

### ORDERING INFORMATION

See detailed ordering and shipping information in the package dimensions section on page 12 of this data sheet.

PIN FUNCTION DESCRIPTION

Pin (SOT23/SC70)	Symbol	Function	Equivalent Circuit
1	OUT	Output	
2	V <sub>EE</sub>	Negative Power Supply	
3	+IN	Non-inverted Input	
4	-IN	Inverted Input	See Above
6	V <sub>CC</sub>	Positive Power Supply	
5	EN	Enable	

ENABLE PIN TRUTH TABLE

	High	Low*
Enable	Disabled	Enabled

\*Default open state

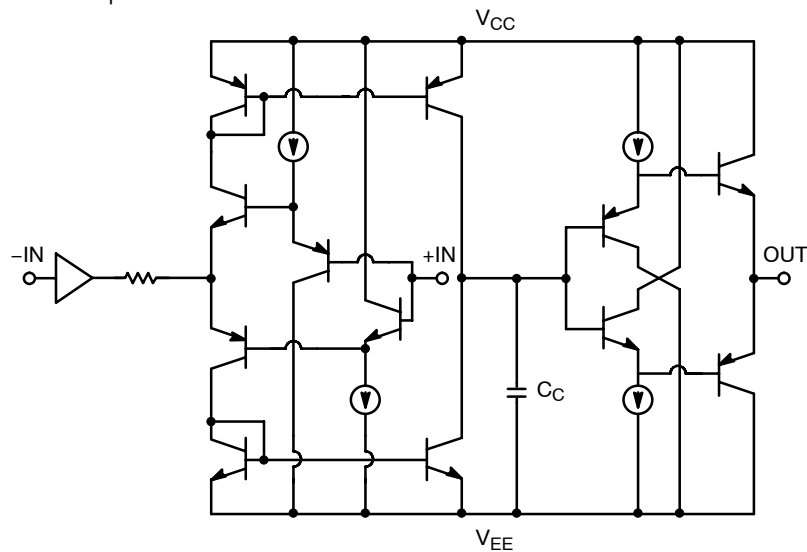

Figure 2. Simplified Device Schematic

**ATTRIBUTES**

Characteristics	Value
ESD	
Human Body Model	2.0 kV
Machine Model	200 V
Charged Device Model	1.0 kV
Moisture Sensitivity (Note 1)	Level 1
Flammability Rating      Oxygen Index: 28 to 34	UL 94 V-0 @ 0.125 in

1. For additional information, see Application Note AND8003/D.

**MAXIMUM RATINGS**

Parameter	Symbol	Rating	Unit
Power Supply Voltage	$V_S$	11	Vdc
Input Voltage Range	$V_I$	$\leq V_S$	Vdc
Input Differential Voltage Range	$V_{ID}$	$\leq V_S$	Vdc
Output Current	$I_O$	100	mA
Maximum Junction Temperature (Note 2)	$T_J$	150	°C
Operating Ambient Temperature	$T_A$	-40 to +85	°C
Storage Temperature Range	$T_{stg}$	-60 to +150	°C
Power Dissipation	$P_D$	(See Graph)	mW
Thermal Resistance, Junction-to-Air	$R_{\theta JA}$	158	°C/W

Stresses exceeding Maximum Ratings may damage the device. Maximum Ratings are stress ratings only. Functional operation above the Recommended Operating Conditions is not implied. Extended exposure to stresses above the Recommended Operating Conditions may affect device reliability.

2. Power dissipation must be considered to ensure maximum junction temperature ( $T_J$ ) is not exceeded.

**MAXIMUM POWER DISSIPATION**

The maximum power that can be safely dissipated is limited by the associated rise in junction temperature. For the plastic packages, the maximum safe junction temperature is 150°C. If the maximum is exceeded momentarily, proper circuit operation will be restored as soon as the die temperature is reduced. Leaving the device in the “overheated” condition for an extended period can result in device damage.

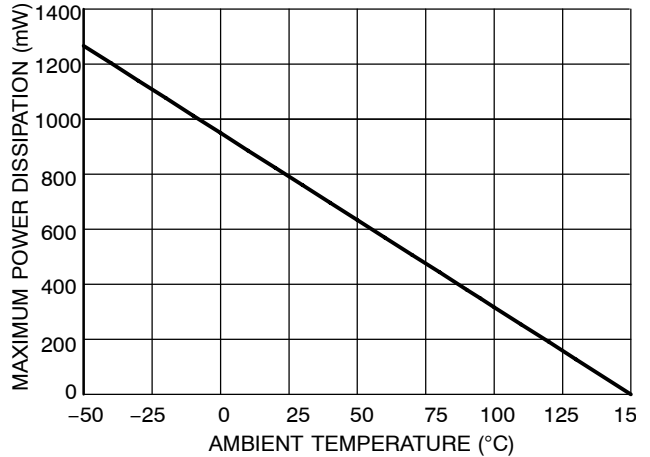

**Figure 3. Power Dissipation vs. Temperature**

## NCS2552

**AC ELECTRICAL CHARACTERISTICS** ( $V_{CC} = +5.0\text{ V}$ ,  $V_{EE} = -5.0\text{ V}$ ,  $T_A = -40^\circ\text{C}$  to  $+85^\circ\text{C}$ ,  $R_L = 150\ \Omega$  to GND,  $R_F = 150\ \Omega$ ,  $A_V = +2.0$ , Enable is left open, unless otherwise specified).

Symbol	Characteristic	Conditions	Min	Typ	Max	Unit
--------	----------------	------------	-----	-----	-----	------

### FREQUENCY DOMAIN PERFORMANCE

BW	Bandwidth 3.0 dB Small Signal 3.0 dB Large Signal	$A_V = +2.0$ , $V_O = 0.5\text{ V}_{p-p}$ $A_V = +2.0$ , $V_O = 2.0\text{ V}_{p-p}$		750 350		MHz
GF <sub>0.1dB</sub>	0.1 dB Gain Flatness Bandwidth	$A_V = +2.0$		40		MHz
dG	Differential Gain	$A_V = +2.0$ , $R_L = 150\ \Omega$ , $f = 3.58\text{ MHz}$		0.07		%
dP	Differential Phase	$A_V = +2.0$ , $R_L = 150\ \Omega$ , $f = 3.58\text{ MHz}$		0.01		°

### TIME DOMAIN RESPONSE

SR	Slew Rate	$A_V = +2.0$ , $V_{step} = 2.0\text{ V}$		1700		V/ $\mu\text{s}$
$t_s$	Settling Time 0.1%	$A_V = +2.0$ , $V_{step} = 2.0\text{ V}$		10		ns
$t_r$ $t_f$	Rise and Fall Time	(10%–90%) $A_V = +2.0$ , $V_{step} = 2.0\text{ V}$		2.0		ns
$t_{ON}$	Turn-on Time			5.0		ns
$t_{OFF}$	Turn-off Time			15		ns

### HARMONIC/NOISE PERFORMANCE

THD	Total Harmonic Distortion	$f = 5.0\text{ MHz}$ , $V_O = 2.0\text{ V}_{p-p}$		-64		dB
HD2	2nd Harmonic Distortion	$f = 5.0\text{ MHz}$ , $V_O = 2.0\text{ V}_{p-p}$		-65		dBc
HD3	3rd Harmonic Distortion	$f = 5.0\text{ MHz}$ , $V_O = 2.0\text{ V}_{p-p}$		-75		dBc
IP3	Third-Order Intercept	$f = 10\text{ MHz}$ , $V_O = 1.0\text{ V}_{p-p}$		40		dBm
SFDR	Spurious-Free Dynamic Range	$f = 5.0\text{ MHz}$ , $V_O = 2.0\text{ V}_{p-p}$		55		dBc
$e_N$	Input Referred Voltage Noise	$f = 1.0\text{ MHz}$		5.0		nV/ $\sqrt{\text{Hz}}$
$i_N$	Input Referred Current Noise	$f = 1.0\text{ MHz}$		4.0		pA/ $\sqrt{\text{Hz}}$

# NCS2552

**DC ELECTRICAL CHARACTERISTICS** ( $V_{CC} = +5.0\text{ V}$ ,  $V_{EE} = -5.0\text{ V}$ ,  $T_A = -40^\circ\text{C}$  to  $+85^\circ\text{C}$ ,  $R_L = 150\ \Omega$  to GND,  $R_F = 150\ \Omega$ ,  $A_V = +2.0$ , Enable is left open, unless otherwise specified). Closed Loop  
Open Loop

Symbol	Characteristic	Conditions	Min	Typ	Max	Unit
--------	----------------	------------	-----	-----	-----	------

## DC PERFORMANCE

$V_{IO}$	Input Offset Voltage		-10	0	+10	mV
$\Delta V_{IO}/\Delta T$	Input Offset Voltage Temperature Coefficient			6.0		$\mu\text{V}/^\circ\text{C}$
$I_{IB}$	Input Bias Current	$V_O = 0\text{ V}$		$\pm 3.2$	$\pm 20$	$\mu\text{A}$
$\Delta I_{IB}/\Delta T$	Input Bias Current Temperature Coefficient	$V_O = 0\text{ V}$		$\pm 40$		$\text{nA}/^\circ\text{C}$
$V_{IH}$	Input High Voltage (Enable) (Note 3)		3.0			V
$V_{IL}$	Input Low Voltage (Enable) (Note 3)				1.0	V

## INPUT CHARACTERISTICS

$V_{CM}$	Input Common Mode Voltage Range (Note 3)		$\pm 3.0$	$\pm 3.2$		V
CMRR	Common Mode Rejection Ratio	(See Graph)	40	50		dB
$R_{IN}$	Input Resistance			4.5		M $\Omega$
$C_{IN}$	Differential Input Capacitance			1.0		pF

## OUTPUT CHARACTERISTICS

$R_{OUT}$	Output Resistance	Closed Loop Open Loop		0.1 13		$\Omega$
$V_O$	Output Voltage Range		$\pm 3.0$	$\pm 4.0$		V
$I_O$	Output Current		$\pm 50$	$\pm 100$		mA

## POWER SUPPLY

$V_S$	Operating Voltage Supply			10		V
$I_{S,ON}$	Power Supply Current – Enabled		5.0	13	17	mA
$I_{S,OFF}$	Power Supply Current – Disabled			0.5	0.8	mA
PSRR	Power Supply Rejection Ratio	(See Graph)	40	56		dB

3. Guaranteed by design and/or characterization.

# NCS2552

**AC ELECTRICAL CHARACTERISTICS** ( $V_{CC} = +2.5\text{ V}$ ,  $V_{EE} = -2.5\text{ V}$ ,  $T_A = -40^\circ\text{C}$  to  $+85^\circ\text{C}$ ,  $R_L = 150\ \Omega$  to GND,  $R_F = 150\ \Omega$ ,  $A_V = +2.0$ , Enable is left open, unless otherwise specified).

Symbol	Characteristic	Conditions	Min	Typ	Max	Unit
--------	----------------	------------	-----	-----	-----	------

## FREQUENCY DOMAIN PERFORMANCE

BW	Bandwidth 3.0 dB Small Signal 3.0 dB Large Signal	$A_V = +2.0$ , $V_O = 0.5\text{ V}_{p-p}$ $A_V = +2.0$ , $V_O = 1.0\text{ V}_{p-p}$		550 200		MHz
$GF_{0.1dB}$	0.1 dB Gain Flatness Bandwidth	$A_V = +2.0$		35		MHz
dG	Differential Gain	$A_V = +2.0$ , $R_L = 150\ \Omega$ , $f = 3.58\text{ MHz}$		0.07		%
dP	Differential Phase	$A_V = +2.0$ , $R_L = 150\ \Omega$ , $f = 3.58\text{ MHz}$		0.02		°

## TIME DOMAIN RESPONSE

SR	Slew Rate	$A_V = +2.0$ , $V_{step} = 1.0\text{ V}$		900		V/ $\mu\text{s}$
$t_s$	Settling Time 0.1%	$A_V = +2.0$ , $V_{step} = 1.0\text{ V}$		10		ns
$t_r$ $t_f$	Rise and Fall Time	(10%–90%) $A_V = +2.0$ , $V_{step} = 1.0\text{ V}$		1.7		ns
$t_{ON}$	Turn-on Time			5.0		ns
$t_{OFF}$	Turn-off Time			15		ns

## HARMONIC/NOISE PERFORMANCE

THD	Total Harmonic Distortion	$f = 5.0\text{ MHz}$ , $V_O = 1.0\text{ V}_{p-p}$		-60		dB
HD2	2nd Harmonic Distortion	$f = 5.0\text{ MHz}$ , $V_O = 1.0\text{ V}_{p-p}$		-65		dBc
HD3	3rd Harmonic Distortion	$f = 5.0\text{ MHz}$ , $V_O = 1.0\text{ V}_{p-p}$		-63		dBc
IP3	Third-Order Intercept	$f = 10\text{ MHz}$ , $V_O = 0.5\text{ V}_{p-p}$		35		dBm
SFDR	Spurious-Free Dynamic Range	$f = 5.0\text{ MHz}$ , $V_O = 1.0\text{ V}_{p-p}$		63		dBc
$e_N$	Input Referred Voltage Noise	$f = 1.0\text{ MHz}$		5.0		nV/ $\sqrt{\text{Hz}}$
$i_N$	Input Referred Current Noise	$f = 1.0\text{ MHz}$		4.0		pA/ $\sqrt{\text{Hz}}$

# NCS2552

**DC ELECTRICAL CHARACTERISTICS** ( $V_{CC} = +2.5\text{ V}$ ,  $V_{EE} = -2.5\text{ V}$ ,  $T_A = -40^\circ\text{C}$  to  $+85^\circ\text{C}$ ,  $R_L = 150\ \Omega$  to GND,  $R_F = 150\ \Omega$ ,  $A_V = +2.0$ , Enable is left open, unless otherwise specified).

Symbol	Characteristic	Conditions	Min	Typ	Max	Unit
--------	----------------	------------	-----	-----	-----	------

## DC PERFORMANCE

$V_{IO}$	Input Offset Voltage		-10	0	+10	mV
$\Delta V_{IO}/\Delta T$	Input Offset Voltage Temperature Coefficient			6.0		$\mu\text{V}/^\circ\text{C}$
$I_{IB}$	Input Bias Current	$V_O = 0\text{ V}$		$\pm 3.2$	$\pm 20$	$\mu\text{A}$
$\Delta I_{IB}/\Delta T$	Input Bias Current Temperature Coefficient	$V_O = 0\text{ V}$		$\pm 40$		$\text{nA}/^\circ\text{C}$
$V_{IH}$	Input High Voltage (Enable) (Note 3)		1.5			V
$V_{IL}$	Input Low Voltage (Enable) (Note 3)				0.5	V

## INPUT CHARACTERISTICS

$V_{CM}$	Input Common Mode Voltage Range (Note 3)		$\pm 1.1$	$\pm 1.6$		V
CMRR	Common Mode Rejection Ratio	(See Graph)	40	50		dB
$R_{IN}$	Input Resistance			4.5		$\text{M}\Omega$
$C_{IN}$	Differential Input Capacitance			1.0		pF

## OUTPUT CHARACTERISTICS

$R_{OUT}$	Output Resistance	Closed Loop Open Loop		0.1 13		$\Omega$
$V_O$	Output Voltage Range		$\pm 1.1$	$\pm 1.6$		V
$I_O$	Output Current		$\pm 50$	$\pm 100$		mA

## POWER SUPPLY

$V_S$	Operating Voltage Supply			5.0		V
$I_{S,ON}$	Power Supply Current – Enabled		5.0	11.5	17	mA
$I_{S,OFF}$	Power Supply Current – Disabled			0.5	0.8	mA
PSRR	Power Supply Rejection Ratio	(See Graph)	40	56		dB

4. Guaranteed by design and/or characterization.

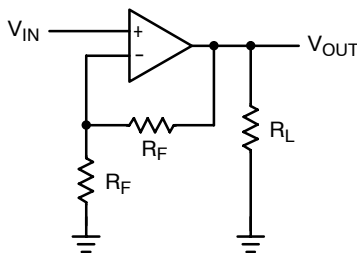

**Figure 4. Typical Test Setup**  
( $A_V = +2.0$ ,  $R_F = 1.0\text{ k}\Omega$ ,  $R_L = 100\ \Omega$ )

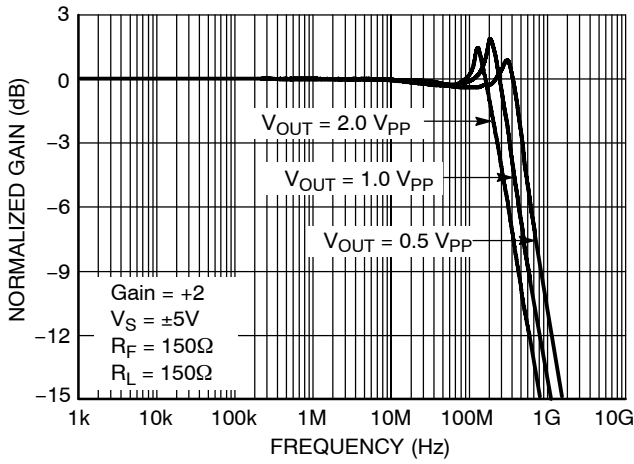

Figure 5. Frequency Response: Gain (dB) vs. Frequency  
Av = +2.0

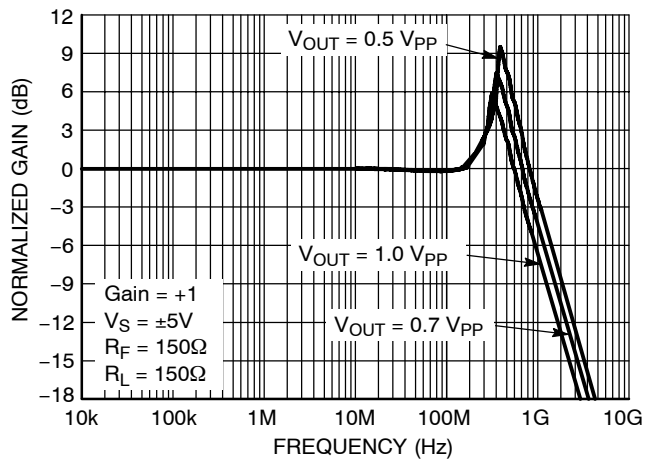

Figure 6. Frequency Response: Gain (dB) vs. Frequency  
Av = +1.0

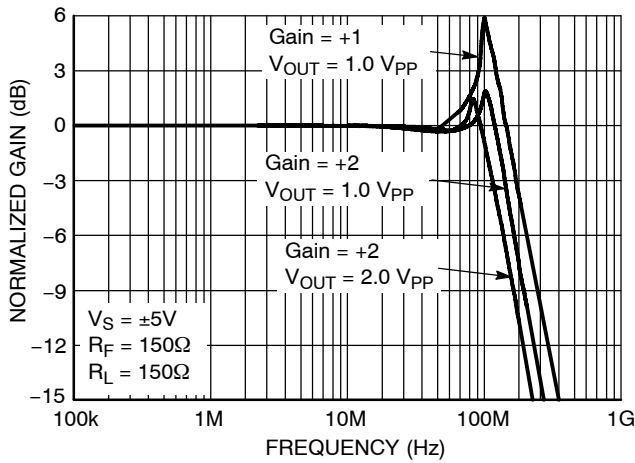

Figure 7. Large Signal Frequency Response Gain (dB) vs. Frequency

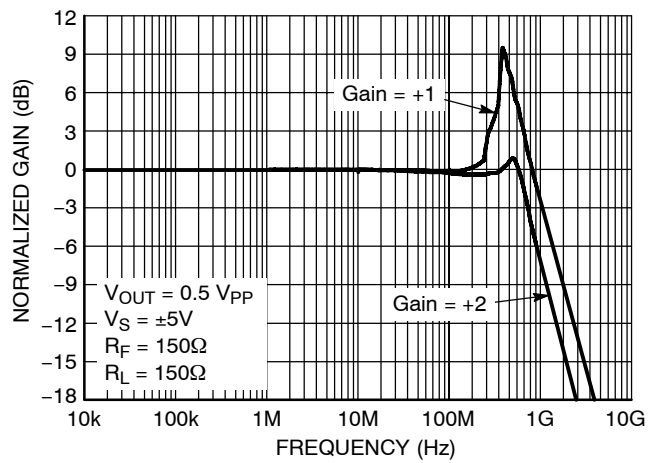

Figure 8. Small Signal Frequency Response Gain (dB) vs. Frequency

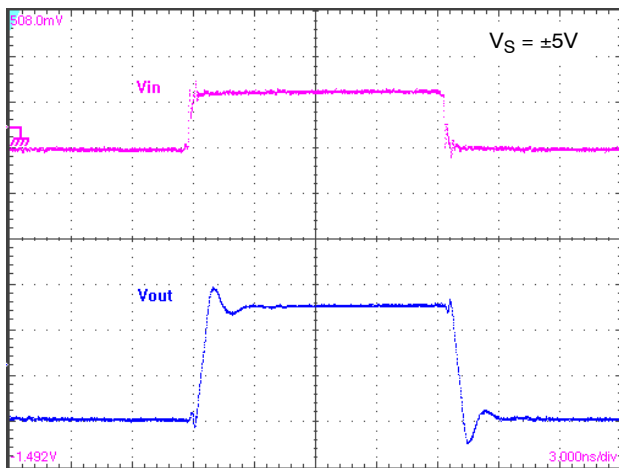

Figure 9. Small Signal Step Response  
Vertical: 20 mV/div  
Horizontal: 3 ns/div

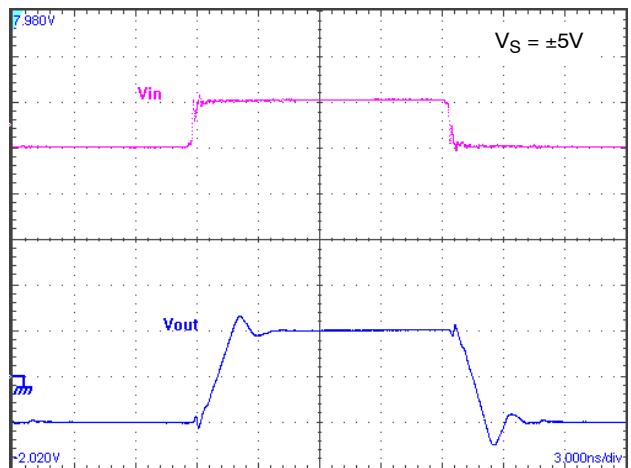

Figure 10. Large Signal Step Response  
Vertical: 1 V/div  
Horizontal: 3 ns/div



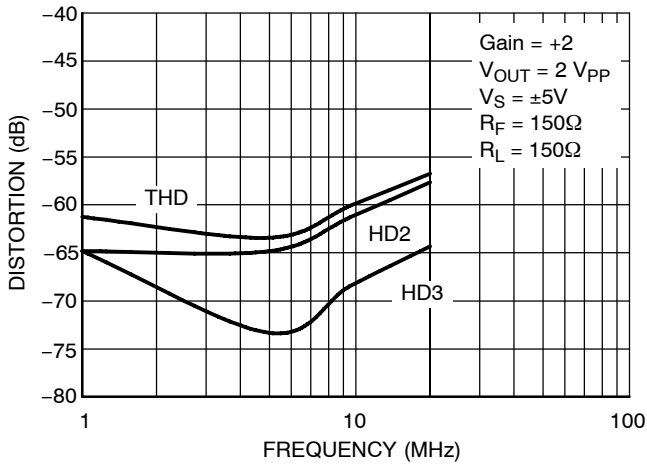

Figure 11. THD, HD2, HD3 vs. Frequency

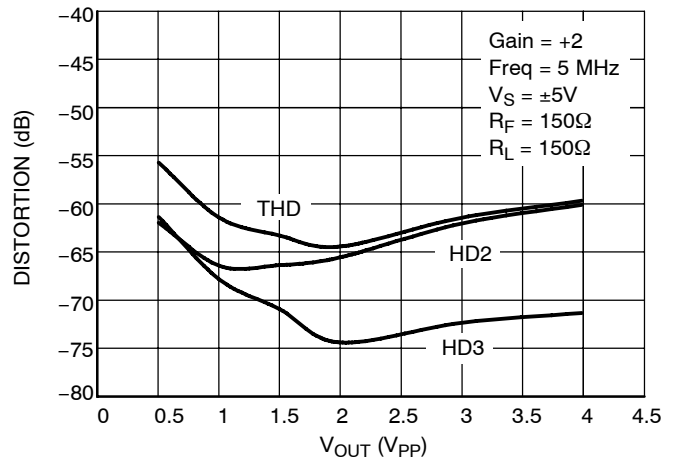

Figure 12. THD, HD2, HD3 vs. Output Voltage

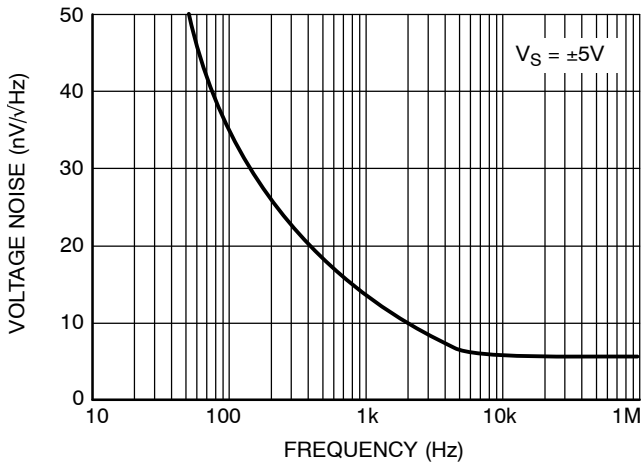

Figure 13. Input Referred Voltage Noise vs. Frequency

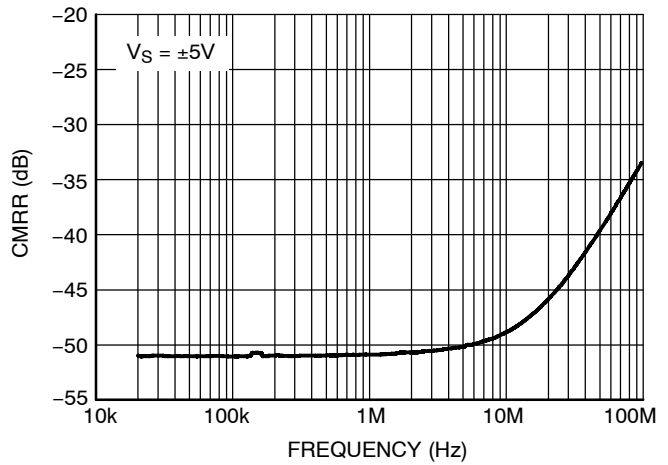

Figure 14. CMRR vs. Frequency

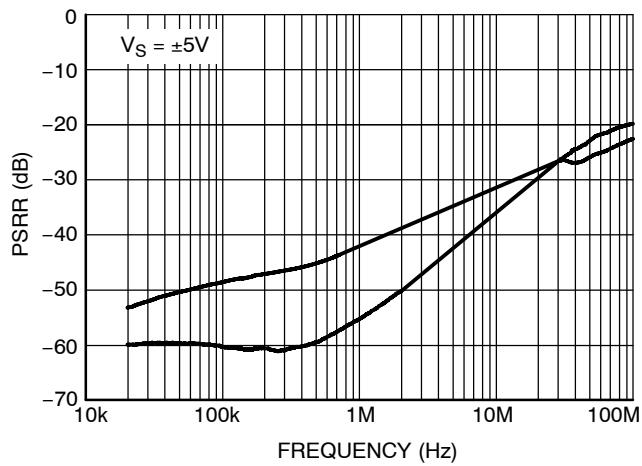

Figure 15. PSRR vs. Frequency

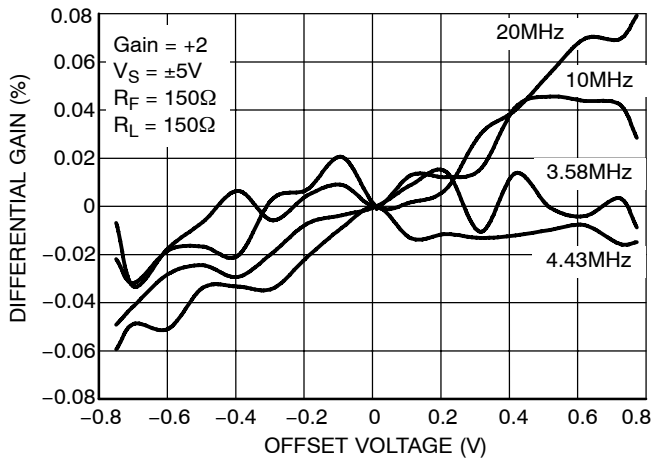

Figure 16. Differential Gain

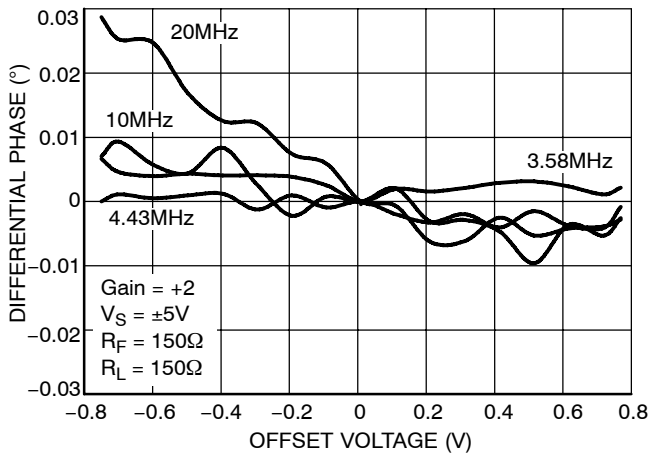

Figure 17. Differential Phase

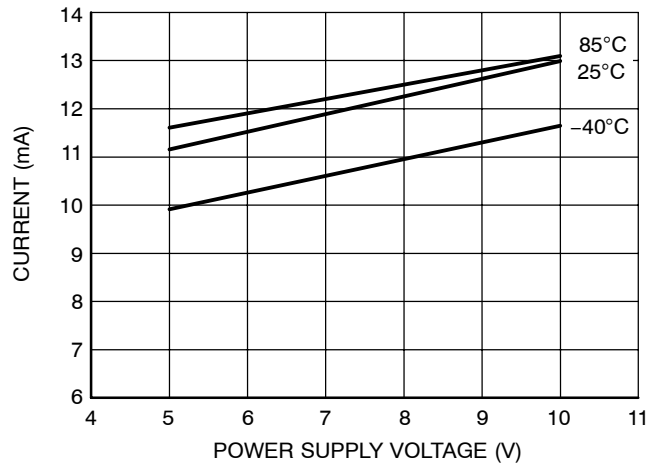

Figure 18. Supply Current vs. Power Supply (Enabled)

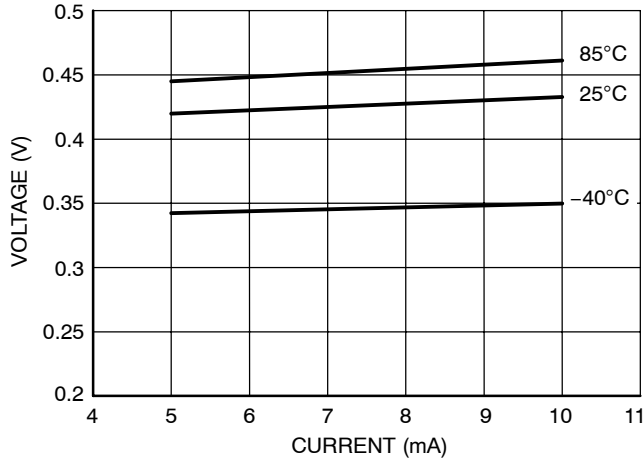

Figure 19. Supply Current (Disabled)

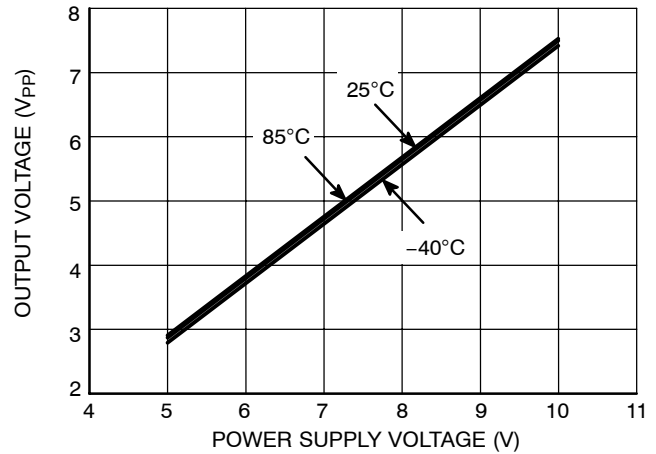

Figure 20. Output Voltage Swing vs. Supply Voltage

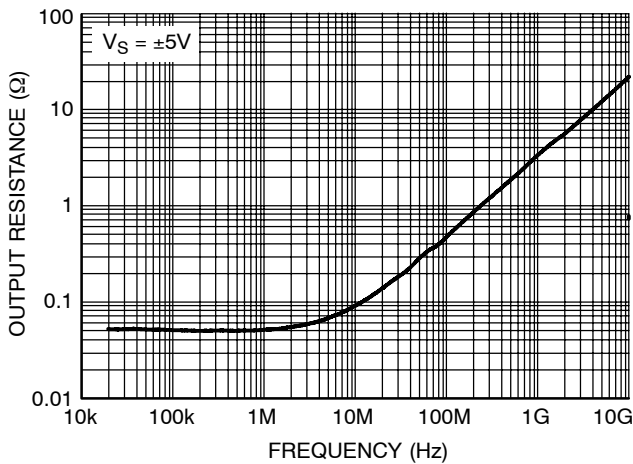

Figure 21. Closed Loop Output Resistance vs. Frequency

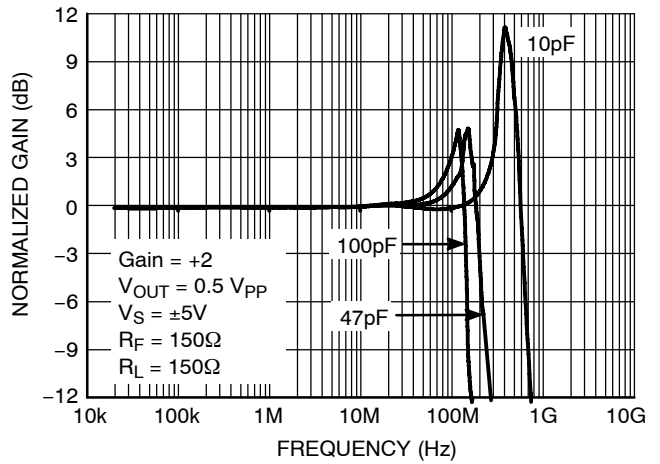
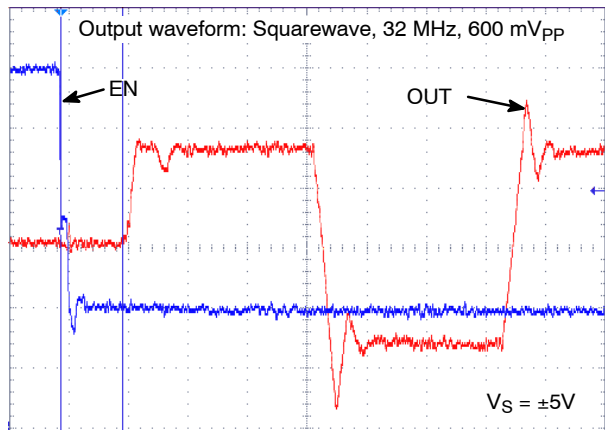
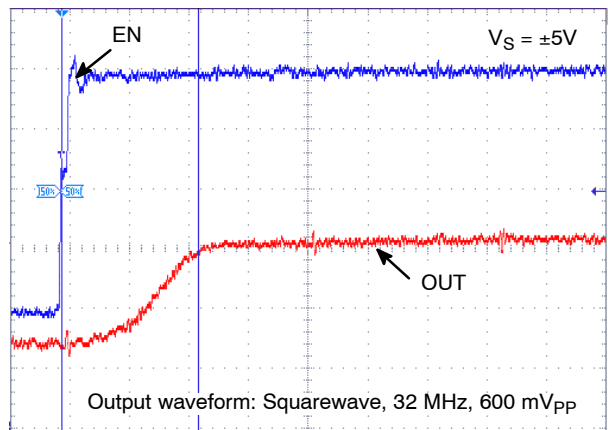

Figure 22. Frequency Response vs. Capacitive Load



**Figure 23. Turn ON Time Delay**  
Vertical: 500 mV/div (Enable), 200 mV/div (Output)  
Horizontal: 5 ns/div



**Figure 24. Turn OFF Time Delay**  
Vertical: 500 mV/div (Enable), 200 mV/div (Output)  
Horizontal: 5 ns/div

**Printed Circuit Board Layout Techniques**

Proper high speed PCB design rules should be used for all wideband amplifiers as the PCB parasitics can affect the overall performance. Most important are stray capacitances at the output and inverting input nodes as it can effect peaking and bandwidth. A space (3/16" is plenty) should be left around the signal lines to minimize coupling. Also, signal lines connecting the feedback and gain resistors should be short enough so that their associated inductance does not cause high frequency gain errors. Line lengths less than 1/4" are recommended.

**Video Performance**

This device designed to provide good performance with NTSC, PAL, and HDTV video signals. Best performance is obtained with back terminated loads as performance is degraded as the load is increased. The back termination reduces reflections from the transmission line and effectively masks transmission line and other parasitic capacitances from the amplifier output stage.

**ESD Protection**

All device pins have limited ESD protection using internal diodes to power supplies as specified in the attributes table (see Figure 25). These diodes provide moderate protection

to input overdrive voltages above the supplies. The ESD diodes can support high input currents with current limiting series resistors. Keep these resistor values as low as possible since high values degrade both noise performance and frequency response. Under closed-loop operation, the ESD diodes have no effect on circuit performance. However, under certain conditions the ESD diodes will be evident. If the device is driven into a slewing condition, the ESD diodes will clamp large differential voltages until the feedback loop restores closed-loop operation. Also, if the device is powered down and a large input signal is applied, the ESD diodes will conduct.

NOTE: Human Body Model for +IN and -IN pins are rated at 0.8kV while all other pins are rated at 2.0kV.

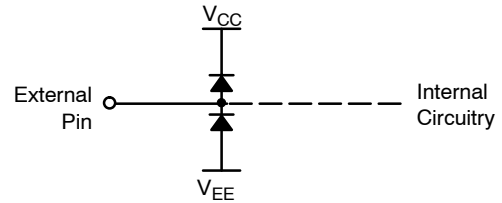

**Figure 25. Internal ESD Protection**

**ORDERING INFORMATION**

Device	Package	Shipping†
NCS2552SNT1G	SOT23-6 (TSOP-6) (Pb-Free)	3000 Tape & Reel

†For information on tape and reel specifications, including part orientation and tape sizes, please refer to our Tape and Reel Packaging Specifications Brochure, BRD8011/D.

# MECHANICAL CASE OUTLINE

## PACKAGE DIMENSIONS



**TSOP-6 3.00x1.50x0.90, 0.95P**  
**CASE 318G**  
**ISSUE W**

DATE 26 FEB 2024



**NOTES:**

1. DIMENSIONING AND TOLERANCING PER ASME Y14.5M, 2018.
2. CONTROLLING DIMENSION: MILLIMETERS.
3. MAXIMUM LEAD THICKNESS INCLUDES LEAD FINISH. MINIMUM LEAD THICKNESS IS THE MINIMUM THICKNESS OF BASE MATERIAL.
4. DIMENSIONS D AND E1 DO NOT INCLUDE MOLD FLASH, PROTRUSIONS, OR GATE BURRS. MOLD FLASH, PROTRUSIONS, OR GATE BURRS SHALL NOT EXCEED 0.15 PER SIDE. DIMENSIONS D AND E1 ARE DETERMINED AT DATUM H.
5. PIN 1 INDICATOR MUST BE LOCATED IN THE INDICATED ZONE

MILLIMETERS			
DIM	MIN	NOM	MAX
A	0.90	1.00	1.10
A1	0.01	0.06	0.10
A2	0.80	0.90	1.00
b	0.25	0.38	0.50
c	0.10	0.18	0.26
D	2.90	3.00	3.10
E	2.50	2.75	3.00
E1	1.30	1.50	1.70
e	0.85	0.95	1.05
L	0.20	0.40	0.60
L2	0.25 BSC		
M	0°	---	10°

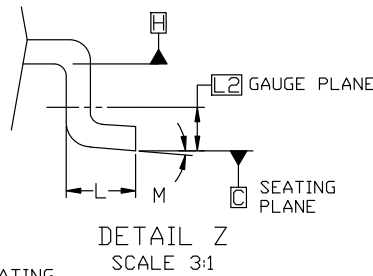

\*For additional information on our Pb-Free strategy and soldering details, please download the ON Semiconductor Soldering and Mounting Techniques Reference manual, SOLDERRM/D.

<b>DOCUMENT NUMBER:</b>	<b>98ASB14888C</b>	Electronic versions are uncontrolled except when accessed directly from the Document Repository. Printed versions are uncontrolled except when stamped "CONTROLLED COPY" in red.
<b>DESCRIPTION:</b>	<b>TSOP-6 3.00x1.50x0.90, 0.95P</b>	<b>PAGE 1 OF 2</b>

onsemi and ONSEMI are trademarks of Semiconductor Components Industries, LLC dba onsemi or its subsidiaries in the United States and/or other countries. onsemi reserves the right to make changes without further notice to any products herein. onsemi makes no warranty, representation or guarantee regarding the suitability of its products for any particular purpose, nor does onsemi assume any liability arising out of the application or use of any product or circuit, and specifically disclaims any and all liability, including without limitation special, consequential or incidental damages. onsemi does not convey any license under its patent rights nor the rights of others.

# MECHANICAL CASE OUTLINE

## PACKAGE DIMENSIONS



TSOP-6 3.00x1.50x0.90, 0.95P  
CASE 318G  
ISSUE W

DATE 26 FEB 2024

### GENERIC MARKING DIAGRAM\*



IC



STANDARD

XXX = Specific Device Code  
A = Assembly Location  
Y = Year  
W = Work Week  
▪ = Pb-Free Package

XXX = Specific Device Code  
M = Date Code  
▪ = Pb-Free Package

\*This information is generic. Please refer to device data sheet for actual part marking. Pb-Free indicator, "G" or microdot "▪", may or may not be present. Some products may not follow the Generic Marking.

STYLE 1:

- PIN 1. DRAIN
- 2. DRAIN
- 3. GATE
- 4. SOURCE
- 5. DRAIN
- 6. DRAIN

STYLE 2:

- PIN 1. EMITTER 2
- 2. BASE 1
- 3. COLLECTOR 1
- 4. EMITTER 1
- 5. BASE 2
- 6. COLLECTOR 2

STYLE 3:

- PIN 1. ENABLE
- 2. N/C
- 3. R BOOST
- 4. Vz
- 5. V in
- 6. V out

STYLE 4:

- PIN 1. N/C
- 2. V in
- 3. NOT USED
- 4. GROUND
- 5. ENABLE
- 6. LOAD

STYLE 5:

- PIN 1. EMITTER 2
- 2. BASE 2
- 3. COLLECTOR 1
- 4. EMITTER 1
- 5. BASE 1
- 6. COLLECTOR 2

STYLE 6:

- PIN 1. COLLECTOR
- 2. COLLECTOR
- 3. BASE
- 4. EMITTER
- 5. COLLECTOR
- 6. COLLECTOR

STYLE 7:

- PIN 1. COLLECTOR
- 2. COLLECTOR
- 3. BASE
- 4. N/C
- 5. COLLECTOR
- 6. EMITTER

STYLE 8:

- PIN 1. Vbus
- 2. D(in)
- 3. D(in)+
- 4. D(out)+
- 5. D(out)
- 6. GND

STYLE 9:

- PIN 1. LOW VOLTAGE GATE
- 2. DRAIN
- 3. SOURCE
- 4. DRAIN
- 5. DRAIN
- 6. HIGH VOLTAGE GATE

STYLE 10:

- PIN 1. D(OUT)+
- 2. GND
- 3. D(OUT)-
- 4. D(IN)-
- 5. VBUS
- 6. D(IN)+

STYLE 11:

- PIN 1. SOURCE 1
- 2. DRAIN 2
- 3. DRAIN 2
- 4. SOURCE 2
- 5. GATE 1
- 6. DRAIN 1/GATE 2

STYLE 12:

- PIN 1. I/O
- 2. GROUND
- 3. I/O
- 4. I/O
- 5. VCC
- 6. I/O

STYLE 13:

- PIN 1. GATE 1
- 2. SOURCE 2
- 3. GATE 2
- 4. DRAIN 2
- 5. SOURCE 1
- 6. DRAIN 1

STYLE 14:

- PIN 1. ANODE
- 2. SOURCE
- 3. GATE
- 4. CATHODE/DRAIN
- 5. CATHODE/DRAIN
- 6. CATHODE/DRAIN

STYLE 15:

- PIN 1. ANODE
- 2. SOURCE
- 3. GATE
- 4. DRAIN
- 5. N/C
- 6. CATHODE

STYLE 16:

- PIN 1. ANODE/CATHODE
- 2. BASE
- 3. EMITTER
- 4. COLLECTOR
- 5. ANODE
- 6. CATHODE

STYLE 17:

- PIN 1. EMITTER
- 2. BASE
- 3. ANODE/CATHODE
- 4. ANODE
- 5. CATHODE
- 6. COLLECTOR

<b>DOCUMENT NUMBER:</b>	<b>98ASB14888C</b>	Electronic versions are uncontrolled except when accessed directly from the Document Repository. Printed versions are uncontrolled except when stamped "CONTROLLED COPY" in red.
<b>DESCRIPTION:</b>	<b>TSOP-6 3.00x1.50x0.90, 0.95P</b>	<b>PAGE 2 OF 2</b>

onsemi and onsemi are trademarks of Semiconductor Components Industries, LLC dba onsemi or its subsidiaries in the United States and/or other countries. onsemi reserves the right to make changes without further notice to any products herein. onsemi makes no warranty, representation or guarantee regarding the suitability of its products for any particular purpose, nor does onsemi assume any liability arising out of the application or use of any product or circuit, and specifically disclaims any and all liability, including without limitation special, consequential or incidental damages. onsemi does not convey any license under its patent rights nor the rights of others.

**onsemi**, **Onsemi**, and other names, marks, and brands are registered and/or common law trademarks of Semiconductor Components Industries, LLC dba "**onsemi**" or its affiliates and/or subsidiaries in the United States and/or other countries. **onsemi** owns the rights to a number of patents, trademarks, copyrights, trade secrets, and other intellectual property. A listing of **onsemi**'s product/patent coverage may be accessed at [www.onsemi.com/site/pdf/Patent-Marking.pdf](http://www.onsemi.com/site/pdf/Patent-Marking.pdf). **onsemi** reserves the right to make changes at any time to any products or information herein, without notice. The information herein is provided "as-is" and **onsemi** makes no warranty, representation or guarantee regarding the accuracy of the information, product features, availability, functionality, or suitability of its products for any particular purpose, nor does **onsemi** assume any liability arising out of the application or use of any product or circuit, and specifically disclaims any and all liability, including without limitation special, consequential or incidental damages. Buyer is responsible for its products and applications using **onsemi** products, including compliance with all laws, regulations and safety requirements or standards, regardless of any support or applications information provided by **onsemi**. "Typical" parameters which may be provided in **onsemi** data sheets and/or specifications can and do vary in different applications and actual performance may vary over time. All operating parameters, including "Typicals" must be validated for each customer application by customer's technical experts. **onsemi** does not convey any license under any of its intellectual property rights nor the rights of others. **onsemi** products are not designed, intended, or authorized for use as a critical component in life support systems or any FDA Class 3 medical devices or medical devices with a same or similar classification in a foreign jurisdiction or any devices intended for implantation in the human body. Should Buyer purchase or use **onsemi** products for any such unintended or unauthorized application, Buyer shall indemnify and hold **onsemi** and its officers, employees, subsidiaries, affiliates, and distributors harmless against all claims, costs, damages, and expenses, and reasonable attorney fees arising out of, directly or indirectly, any claim of personal injury or death associated with such unintended or unauthorized use, even if such claim alleges that **onsemi** was negligent regarding the design or manufacture of the part. **onsemi** is an Equal Opportunity/Affirmative Action Employer. This literature is subject to all applicable copyright laws and is not for resale in any manner.

## ADDITIONAL INFORMATION

### TECHNICAL PUBLICATIONS:

Technical Library: [www.onsemi.com/design/resources/technical-documentation](http://www.onsemi.com/design/resources/technical-documentation)  
onsemi Website: [www.onsemi.com](http://www.onsemi.com)

### ONLINE SUPPORT: [www.onsemi.com/support](http://www.onsemi.com/support)

For additional information, please contact your local Sales Representative at [www.onsemi.com/support/sales](http://www.onsemi.com/support/sales)

