



Is Now Part of



**ON Semiconductor®**

To learn more about ON Semiconductor, please visit our website at  
[www.onsemi.com](http://www.onsemi.com)

Please note: As part of the Fairchild Semiconductor integration, some of the Fairchild orderable part numbers will need to change in order to meet ON Semiconductor's system requirements. Since the ON Semiconductor product management systems do not have the ability to manage part nomenclature that utilizes an underscore (\_), the underscore (\_) in the Fairchild part numbers will be changed to a dash (-). This document may contain device numbers with an underscore (\_). Please check the ON Semiconductor website to verify the updated device numbers. The most current and up-to-date ordering information can be found at [www.onsemi.com](http://www.onsemi.com). Please email any questions regarding the system integration to [Fairchild\\_questions@onsemi.com](mailto:Fairchild_questions@onsemi.com).

ON Semiconductor and the ON Semiconductor logo are trademarks of Semiconductor Components Industries, LLC dba ON Semiconductor or its subsidiaries in the United States and/or other countries. ON Semiconductor owns the rights to a number of patents, trademarks, copyrights, trade secrets, and other intellectual property. A listing of ON Semiconductor's product/patent coverage may be accessed at [www.onsemi.com/site/pdf/Patent-Marking.pdf](http://www.onsemi.com/site/pdf/Patent-Marking.pdf). ON Semiconductor reserves the right to make changes without further notice to any products herein. ON Semiconductor makes no warranty, representation or guarantee regarding the suitability of its products for any particular purpose, nor does ON Semiconductor assume any liability arising out of the application or use of any product or circuit, and specifically disclaims any and all liability, including without limitation special, consequential or incidental damages. Buyer is responsible for its products and applications using ON Semiconductor products, including compliance with all laws, regulations and safety requirements or standards, regardless of any support or applications information provided by ON Semiconductor. "Typical" parameters which may be provided in ON Semiconductor data sheets and/or specifications can and do vary in different applications and actual performance may vary over time. All operating parameters, including "Typicals" must be validated for each customer application by customer's technical experts. ON Semiconductor does not convey any license under its patent rights nor the rights of others. ON Semiconductor products are not designed, intended, or authorized for use as a critical component in life support systems or any FDA Class 3 medical devices or medical devices with a same or similar classification in a foreign jurisdiction or any devices intended for implantation in the human body. Should Buyer purchase or use ON Semiconductor products for any such unintended or unauthorized application, Buyer shall indemnify and hold ON Semiconductor and its officers, employees, subsidiaries, affiliates, and distributors harmless against all claims, costs, damages, and expenses, and reasonable attorney fees arising out of, directly or indirectly, any claim of personal injury or death associated with such unintended or unauthorized use, even if such claim alleges that ON Semiconductor was negligent regarding the design or manufacture of the part. ON Semiconductor is an Equal Opportunity/Affirmative Action Employer. This literature is subject to all applicable copyright laws and is not for resale in any manner.



## FSBH0F70WA, FSBH0170W, FSBH0270W Green Mode Fairchild Power Switch (FPS™)

### Features

- Brownout Protection with Hysteresis
- Built-In 5 ms Soft-Start Function
- Internal Avalanche-Rugged 700 V SenseFET
- Low Acoustic Noise During Light-Load Operation
- High-Voltage Startup
- Linearly Decreasing PWM Frequency to 18 KHz
- Peak-Current-Mode Control
- Cycle-by-Cycle Current Limiting
- Leading-Edge Blanking (LEB)
- Synchronized Slope Compensation
- Internal Open-Loop Protection
- $V_{DD}$  Under-Voltage Lockout (UVLO)
- $V_{DD}$  Over-Voltage Protection (OVP)
- Internal Auto-Restart Circuit (OVP, OTP)
- Constant Power Limit (Full AC Input Range)
- Internal OTP Sensor with Hysteresis

### Applications

General-purpose switched-mode power supplies and flyback power converters, including:

- Auxiliary Power Supply for PC and Server
- SMPS for VCR, SVR, STB, DVD & DVCD Player, Printer, Facsimile, and Scanner
- Adapter for Camcorder

### Description

The highly integrated FSBH-series consists of an integrated current-mode Pulse Width Modulator (PWM) and an avalanche-rugged 700 V SenseFET. It is specifically designed for high-performance offline Switched-Mode Power Supplies (SMPS) with minimal external components.

The integrated PWM controller features include a proprietary green-mode function that provides off-time modulation to linearly decrease the switching frequency at light-load conditions to minimize standby power consumption. To avoid acoustic-noise problems, the minimum PWM frequency is set above 18 kHz. This green-mode function enables the power supply to meet international power conservation requirements. The PWM controller is manufactured using the BiCMOS process to further reduce power consumption. The FSBH-series turns off some internal circuits to improve power saving when  $V_{FB}$  is lower than 1.6 V, which allows an operating current of only 2.5 mA.

The FSBH-series has built-in synchronized slope compensation to achieve stable peak-current-mode control. The proprietary external line compensation ensures constant output power limit over a wide AC input voltage range, from 90  $V_{AC}$  to 264  $V_{AC}$ .

The FSBH-series provides many protection functions. In addition to cycle-by-cycle current limiting, the internal open-loop protection circuit ensures safety when an open-loop or output short occurs. PWM output is disabled until  $V_{DD}$  drops below the  $V_{TH-OLP}$ , then the controller starts up again. As long as  $V_{DD}$  exceeds 28 V, the internal OVP circuit is triggered.

Compared with a discrete MOSFET and controller or RCC switching converter solution, the FSBH-series reduces component count, design size, and weight; while increasing efficiency, productivity, and system reliability. These devices provide a basic platform that is well suited for the design of cost-effective flyback converters, such as in PC auxiliary power supplies.

### Ordering Information

Part Number	SenseFET	VIN Pin (PIN #4)	Operating Temperature Range	Package	Packing Method
FSBH0F70WANY	0.5 A 700 V	Not Available	-40°C to +105°C	8-Pin, Dual In-Line Package (DIP)	Tube
FSBH0170WNY	1.0 A 700 V	Enabled			
FSBH0270WNY	2.0 A 700 V				

### Typical Application Diagram

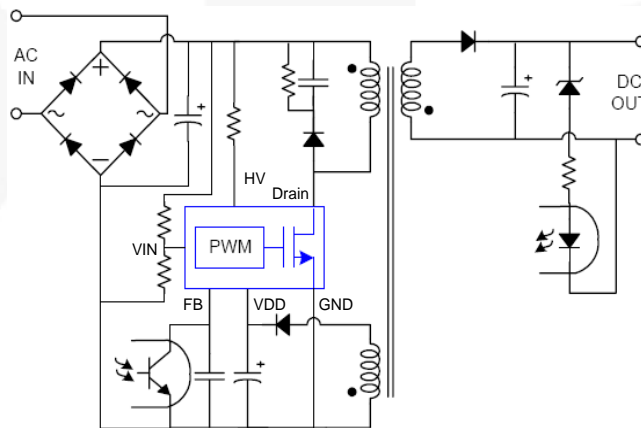

Figure 1. Typical Flyback Application

Table 1. Output Power Table<sup>(1)</sup>

Product	230 V <sub>AC</sub> ± 15% <sup>(2)</sup>		85-265 V <sub>AC</sub>	
	Adapter <sup>(3)</sup>	Open Frame <sup>(4)</sup>	Adapter <sup>(3)</sup>	Open Frame <sup>(4)</sup>
FSBH0F70WA	7 W	10 W	6 W	8 W
FSBH0170W	10 W	15 W	9 W	13 W
FSBH0270W	14 W	20 W	11 W	16 W

**Notes:**

1. The maximum output power can be limited by junction temperature.
2. 230 V<sub>AC</sub> or 100/115 V<sub>AC</sub> with doublers.
3. Typical continuous power in a non-ventilated enclosed adapter with sufficient drain pattern as a heat sink at 50°C ambient.
4. Maximum practical continuous power in an open-frame design with sufficient drain pattern as a heat sink at 50°C ambient.



## Pin Configuration

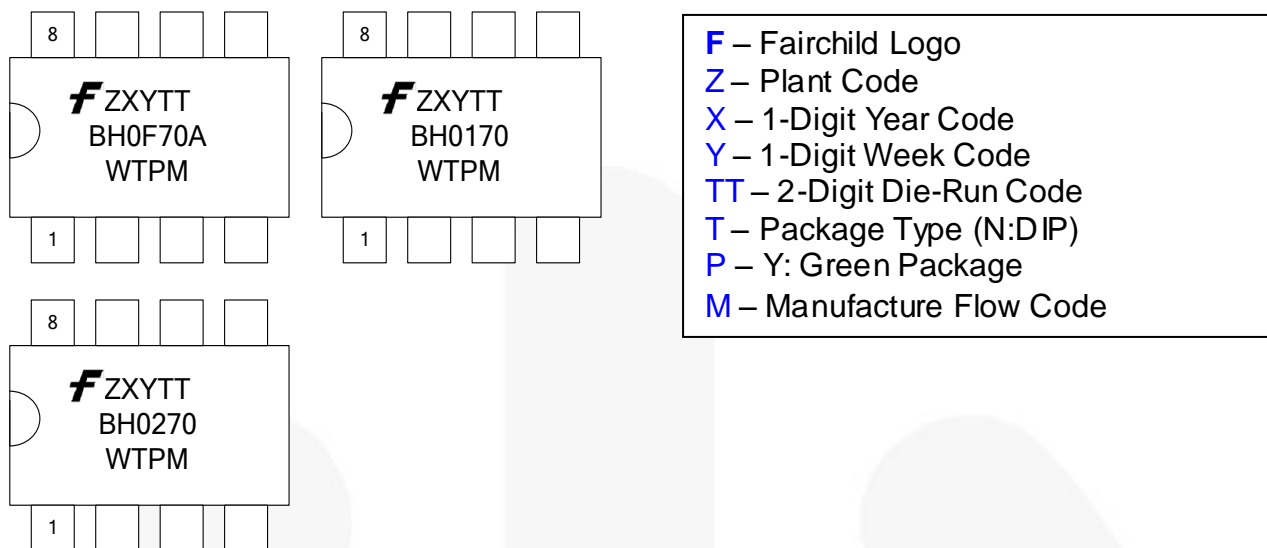

Figure 4. Pin Configuration and Top Mark Information

## Pin Definitions

Pin #	Name	Description
1	GND	<b>Ground.</b> SenseFET source terminal on primary side and internal controller ground.
2	VDD	<b>Power Supply.</b> The internal protection circuit disables PWM output as long as $V_{DD}$ exceeds the OVP trigger point.
3	FB	<b>Feedback.</b> The signal from the external compensation circuit is fed into this pin. The PWM duty cycle is determined in response to the signal on this pin and the internal current-sense signal.
4	VIN	<b>Line-Voltage Detection.</b> The line-voltage detection is used for brownout protection with hysteresis and constant output power limit over universal AC input range.
	NC	No Connection for FSBH0F70WA
5	HV	<b>Startup.</b> For startup, this pin is pulled HIGH to the line input or bulk capacitor via resistors.
6	Drain	<b>SenseFET Drain.</b> High-voltage power SenseFET drain connection.
7	Drain	<b>SenseFET Drain.</b> High-voltage power SenseFET drain connection.
8	Drain	<b>SenseFET Drain.</b> High-voltage power SenseFET drain connection.

## Absolute Maximum Ratings

Stresses exceeding the absolute maximum ratings may damage the device. The device may not function or be operable above the recommended operating conditions and stressing the parts to these levels is not recommended. In addition, extended exposure to stresses above the recommended operating conditions may affect device reliability. The absolute maximum ratings are stress ratings only.

Symbol	Parameter	Min.	Max.	Unit
V <sub>DRAIN</sub>	Drain Pin Voltage <sup>(5,6)</sup>	FSBH0F70WA	700	V
		FSBH0170W		
		FSBH0270W		
I <sub>DM</sub>	Drain Current Pulsed <sup>(7)</sup>	FSBH0F70WA	1.5	A
		FSBH0170W	4.0	
		FSBH0270W	8.0	
E <sub>AS</sub>	Single Pulsed Avalanche Energy <sup>(8)</sup>	FSBH0F70WA	10	mJ
		FSBH0170W	50	
		FSBH0270W	140	
V <sub>DD</sub>	DC Supply Voltage		30	V
V <sub>FB</sub>	FB Pin Input Voltage	-0.3	7.0	V
V <sub>IN</sub>	VIN Pin Input Voltage	-0.3	7.0	V
V <sub>HV</sub>	HV Pin Input Voltage		700	V
P <sub>D</sub>	Power Dissipation (T <sub>A</sub> < 50°C)		1.5	W
Θ <sub>JA</sub>	Junction-to-Air Thermal Resistance		80	°C/W
ψ <sub>JT</sub>	Junction-to-Top Thermal Resistance <sup>(9)</sup>		20	°C/W
T <sub>J</sub>	Operating Junction Temperature	Internally limited <sup>(10)</sup>		°C
T <sub>STG</sub>	Storage Temperature Range	-55	+150	°C
T <sub>L</sub>	Lead Temperature (Wave Soldering or IR, 10 Seconds)		+260	°C
ESD	Human Body Model (All Pins Except HV Pn): JESD22-A114	FSBH0F70WA	5.0	kV
		FSBH0170W	5.0	
		FSBH0270W	5.0	
	Charged Device Model (All Pins Except HV Pin): JESD22-C101	FSBH0F70WA	2.0	
		FSBH0170W	2.0	
		FSBH0270W	2.0	

### Notes:

5. All voltage values, except differential voltages, are given with respect to the network ground terminal.
6. Stresses beyond those listed under Absolute Maximum Ratings may cause permanent damage to the device.
7. Non-repetitive rating: pulse width is limited by maximum junction temperature.
8. L = 51 mH, starting T<sub>J</sub> = 25°C.
9. Measured on the package top surface.
10. Internally Limited of T<sub>J</sub> refers to T<sub>OTP</sub>

## Recommended Operating Conditions

The Recommended Operating Conditions table defines the conditions for actual device operation. Recommended operating conditions are specified to ensure optimal performance to the datasheet specifications. Fairchild does not recommend exceeding them or designing to Absolute Maximum Ratings.

Symbol	Parameter	Min.	Max.	Unit
T <sub>A</sub>	Operating Ambient Temperature	-40	+105	°C

## Electrical Characteristics

$V_{DD}=15\text{ V}$  and  $T_A=25^\circ\text{C}$  unless otherwise specified.

Symbol	Parameter	Condition	Min.	Typ.	Max.	Unit
<b>SenseFET Section</b>						
$BV_{DSS}$	Drain-Source Breakdown Voltage	$I_D=250\ \mu\text{A}$ , $V_{GS}=0\ \text{V}$	700			V
$I_{DSS}$	Zero-Gate-Voltage Drain Current	$V_{DS}=700\ \text{V}$ , $V_{GS}=0\ \text{V}$			50	$\mu\text{A}$
		$V_{DS}=560\ \text{V}$ , $V_{GS}=0\ \text{V}$ , $T_C=125^\circ\text{C}$			200	
$R_{DS(ON)}$	Drain-Source On-State Resistance <sup>(12)</sup>	$V_{GS}=10\ \text{V}$ , $I_D=0.5\ \text{A}$	FSBH0F70WA	14.00	19.00	$\Omega$
			FSBH0170W	8.80	11.00	
			FSBH0270W	6.00	7.20	
$C_{ISS}$	Input Capacitance	$V_{GS}=0\ \text{V}$ , $V_{DS}=25\ \text{V}$ , $f=1\ \text{MHz}$	FSBH0F70WA	162	211	$\text{pF}$
			FSBH0170W	250	325	
			FSBH0270W	550	715	
$C_{OSS}$	Output Capacitance	$V_{GS}=0\ \text{V}$ , $V_{DS}=25\ \text{V}$ , $f=1\ \text{MHz}$	FSBH0F70WA	18	24	$\text{pF}$
			FSBH0170W	25	33	
			FSBH0270W	38	50	
$C_{RSS}$	Reverse Transfer Capacitance	$V_{GS}=0\ \text{V}$ , $V_{DS}=25\ \text{V}$ , $f=1\ \text{MHz}$	FSBH0F70WA	3.8	5.7	$\text{pF}$
			FSBH0170W	10	15	
			FSBH0270W	17	26	
$t_{D(ON)}$	Turn-On Delay	$V_{DS}=350\ \text{V}$ , $I_D=1.0\ \text{A}$	FSBH0F70WA	9.5	29.0	ns
			FSBH0170W	12.0	34.0	
			FSBH0270W	20.0	50.0	
$t_R$	Rise Time	$V_{DS}=350\ \text{V}$ , $I_D=1.0\ \text{A}$	FSBH0F70WA	19	48	ns
			FSBH0170W	4	18	
			FSBH0270W	15	40	
$t_{D(OFF)}$	Turn-Off Delay	$V_{DS}=350\ \text{V}$ , $I_D=1.0\ \text{A}$	FSBH0F70WA	33.0	76.0	ns
			FSBH0170W	30.0	70.0	
			FSBH0270W	55.0	120.0	
$t_F$	Fall Time	$V_{DS}=350\ \text{V}$ , $I_D=1.0\ \text{A}$	FSBH0F70WA	42	94	ns
			FSBH0170W	10	30	
			FSBH0270W	25	60	

Continued on the following page...

## Electrical Characteristics (Continued)

$V_{DD}=15\text{ V}$  and  $T_A=25^\circ\text{C}$  unless otherwise specified.

Symbol	Parameter	Condition	Min.	Typ.	Max.	Unit
<b>Control Section</b>						
<b>V<sub>DD</sub> Section</b>						
$V_{DD-ON}$	Start Threshold Voltage		11	12	13	V
$V_{DD-OFF}$	Minimum Operating Voltage		7	8	9	V
$I_{DD-ST}$	Startup Current	FSBH0170W FSBH0270W	$V_{DD-ON} - 0.16\text{ V}$		30	$\mu\text{A}$
		FSBH0F70WA	$V_{DD-ON} - 0.16\text{ V}$		240 320 400	
$I_{DD-OP}$	Operating Supply Current	$V_{DD}=15\text{ V}$ , $V_{FB}=3\text{ V}$	3.0	3.5	4.0	$\text{mA}$
$I_{DD-ZDC}$	Operating Current for $V_{FB} < V_{FB-ZDC}$	$V_{DD}=12\text{ V}$ , $V_{FB}=1.6\text{ V}$	1.5	2.5	3.5	$\text{mA}$
$I_{DD-OLP}$	Internal Sink Current	$V_{TH-OLP}+0.1\text{ V}$	30	70	90	$\mu\text{A}$
$V_{TH-OLP}$	$I_{DD-OLP}$ Off Voltage		5	6	7	V
$V_{DD-OVP}$	$V_{DD}$ Over-Voltage Protection		27	28	29	V
$t_{D-VDD-OVP}$	$V_{DD}$ Over-Voltage Protection Debounce Time		75	130	200	$\mu\text{s}$
<b>HV Section</b>						
$I_{HV}$	Maximum Current Drawn from HV Pin	HV 120 $V_{DC}$ , $V_{DD}=0\text{ V}$ with 10 $\mu\text{F}$	1.5	3.5	5.0	$\text{mA}$
$I_{HV-LC}$	Leakage Current after Startup	HV=700 V, $V_{DD}=V_{DD-OFF}+1\text{ V}$		1	20	$\mu\text{A}$
<b>Oscillator Section</b>						
$f_{OSC}$	Frequency in Nominal Mode	Center Frequency	94	100	106	$\text{kHz}$
$f_{OSC-G}$	Green-Mode Frequency		14	18	22	$\text{kHz}$
$D_{MAX}$	Maximum Duty Cycle			85		%
$f_{DV}$	Frequency Variation vs. $V_{DD}$ Deviation	$V_{DD}=11\text{ V}$ to $22\text{ V}$			5	%
$f_{DT}$	Frequency Variation vs. Temperature Deviation <sup>(1)</sup>	$T_A=-25$ to $85^\circ\text{C}$			5	%
<b>V<sub>IN</sub> Section (FSBH0170W &amp; FSBH0270W)</b>						
$V_{IN-ON}$	PWM Turn-On Threshold Voltage		1.08	1.13	1.18	V
$V_{IN-OFF}$	PWM Turn-Off Threshold Voltage		0.50	0.55	0.60	V
$t_{IN-OFF}$	PWM Turn-Off Debounce Time			500		ms
<b>Feedback Input Section</b>						
$A_V$	FB Voltage to Current-Sense Attenuation		1/4.5	1/4.0	1/3.5	V/V
$Z_{FB}$	Input Impedance		4		7	$\text{k}\Omega$
$V_{FB-OPEN}$	Output High Voltage	FB Pin Open	5.5			V

Continued on the following page...



### Electrical Characteristics (Continued)

V<sub>DD</sub>=15 V and T<sub>A</sub>=25°C unless otherwise specified.

Symbol	Parameter	Condition	Min.	Typ.	Max.	Unit	
V <sub>FB-N</sub>	Green-Mode Entry FB Voltage		2.3	2.5	2.7	V	
V <sub>FB-G</sub>	Green-Mode Ending FB Voltage		1.9	2.0	2.1	V	
V <sub>FB-ZDC</sub>	Zero Duty Cycle FB Voltage			1.6		V	
V <sub>FB-OLP</sub>	FB Open-Loop Trigger Level	FSBH0F70WA	5.2	5.4	5.6	V	
		FSBH0x7W	4.4	4.6	4.8		
t <sub>D-OLP</sub>	FB Open-Loop Protection Delay		50	56	59	ms	
<b>Current-Sense Section<sup>(15)</sup></b>							
I <sub>LIM</sub>	Peak Current Limit	FSBH0F70WA	V <sub>IN</sub> Open	0.63	0.73	0.83	A
		FSBH0170W	V <sub>IN</sub> =1.2 V	0.70	0.80	0.90	
		FSBH0270W	V <sub>IN</sub> =1.2 V	0.90	1.00	1.10	
t <sub>SS</sub>	Period During Soft-Start Time <sup>(11)</sup>		4.5	5.0	5.5	ms	
<b>Constant Power Limit (FSBH0170W &amp; FSBH0270W)</b>							
V <sub>LMT1</sub>	Threshold Voltage 1 for Current Limit	V <sub>IN</sub> =1.2 V	0.73	0.80	0.87	V	
V <sub>LMT2</sub>	Threshold Voltage 2 for Current Limit	V <sub>IN</sub> =3.6 V	0.56	0.63	0.70	V	
<b>Constant Power Limit (FSBH0F70WA)</b>							
V <sub>LMT</sub>	Threshold Voltage for Current Limit		0.97	1.00	1.03	V	
<b>Over-Temperature Protection Section (OTP)</b>							
T <sub>OTP</sub>	Protection Junction Temperature <sup>(11,13)</sup>		+135	+142	+150	°C	
T <sub>RESTART</sub>	Restart Junction Temperature <sup>(11,14)</sup>			T <sub>OTP</sub> -25		°C	

**Notes:**

11. These parameters, although guaranteed, are not 100% tested in production.
12. Pulse test: pulse width ≤ 300 μs, duty ≤ 2%.
13. When activated, the output is disabled and the latch is turned off.
14. The threshold temperature for enabling the output again and resetting the latch after over-temperature protection has been activated.
15. These parameters, although guaranteed, are tested in wafer process.

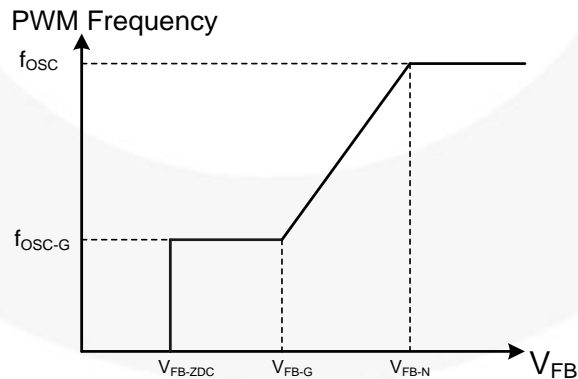

**Figure 5. V<sub>FB</sub> vs. PWM Frequency**

Typical Characteristics (Continued)

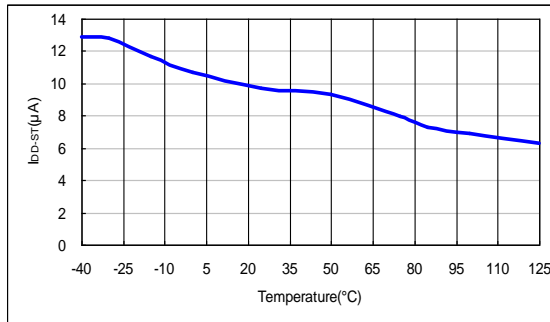

Figure 6. I<sub>DD-ST</sub> vs. Temperature

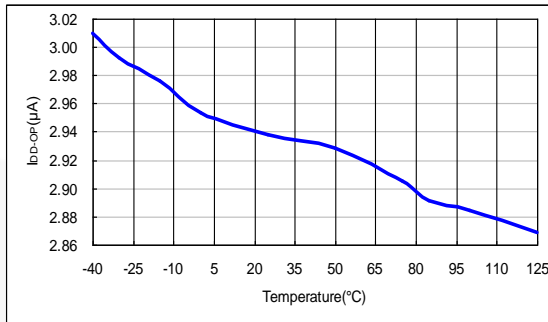

Figure 7. I<sub>DD-OP</sub> vs. Temperature

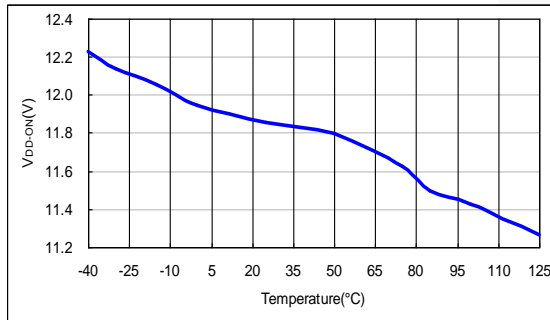

Figure 8. V<sub>DD-ON</sub> vs. Temperature

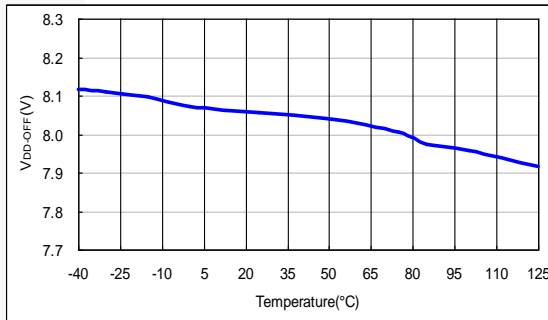

Figure 9. V<sub>DD-OFF</sub> vs. Temperature

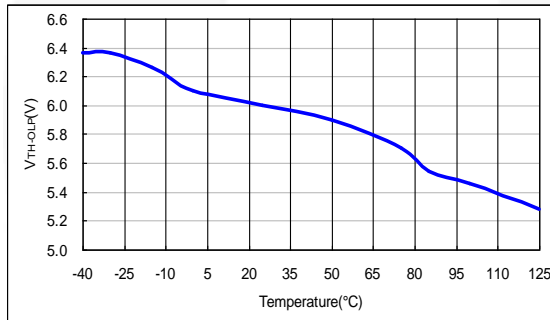

Figure 10. V<sub>TH-OLP</sub> vs. Temperature

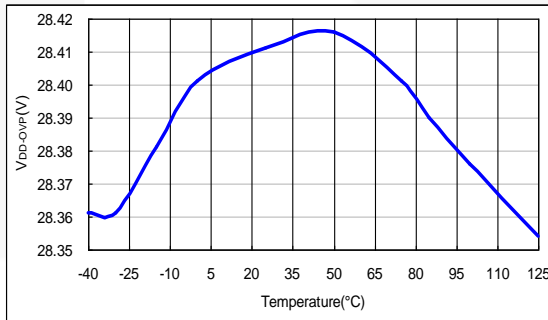

Figure 11. V<sub>DD-OVP</sub> vs. Temperature

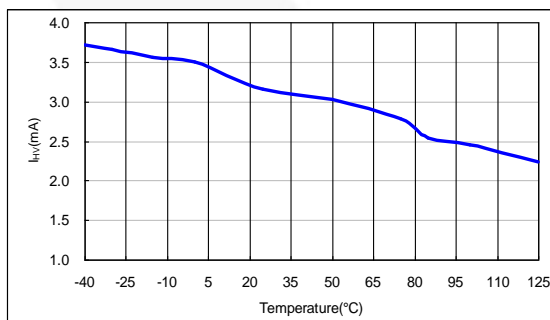

Figure 12. I<sub>HV</sub> vs. Temperature

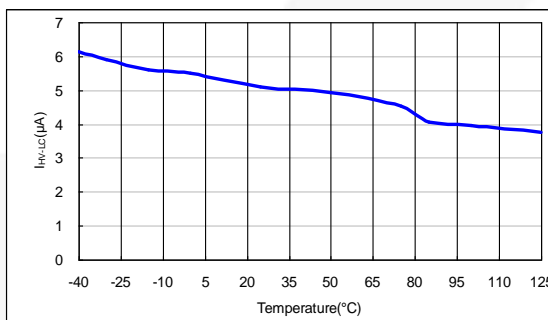

Figure 13. I<sub>HV-LC</sub> vs. Temperature

## Typical Characteristics (Continued)

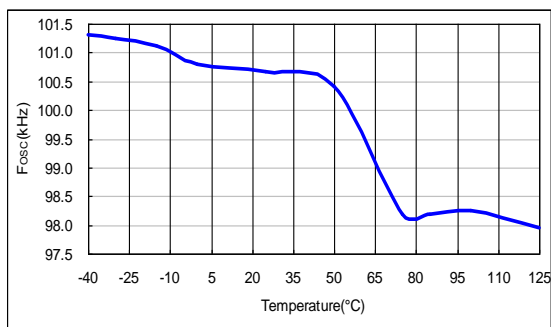

Figure 14. f<sub>osc</sub> vs. Temperature

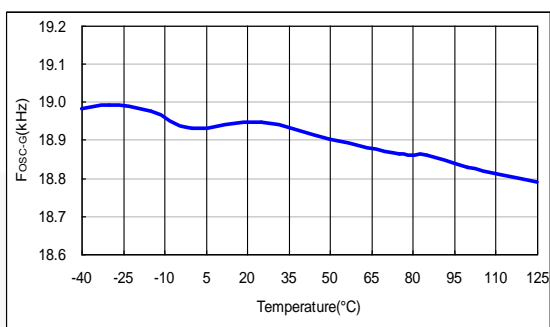

Figure 15. f<sub>osc-g</sub> vs. Temperature

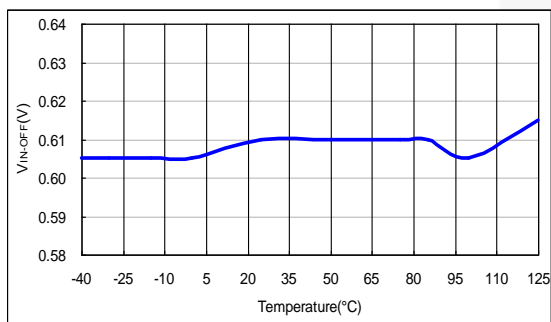

Figure 16. V<sub>IN-OFF</sub> vs. Temperature

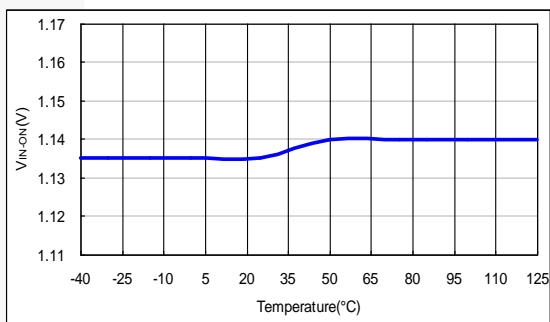

Figure 17. V<sub>IN-ON</sub> vs. Temperature

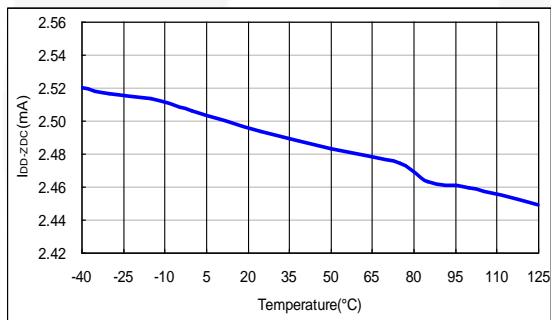

Figure 18. I<sub>DD-ZDC</sub> vs. Temperature

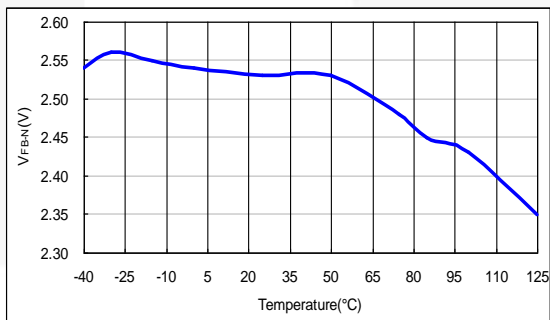

Figure 19. V<sub>FB-N</sub> vs. Temperature

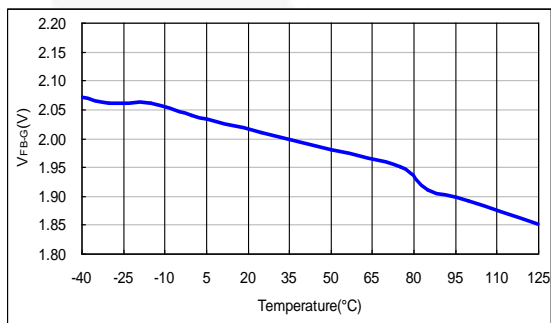

Figure 20. V<sub>FB-G</sub> vs. Temperature

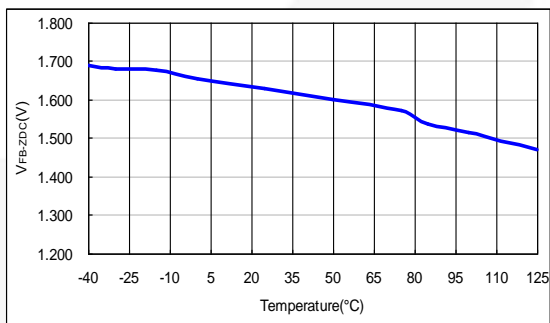

Figure 21. V<sub>FB-ZDC</sub> vs. Temperature

## Functional Description

### Startup Operation

The HV pin is connected to bulk voltage through an external resistor,  $R_{HV}$ , as shown in Figure 22. When AC voltage is applied to the power system, an internal HV startup circuit provides a high current (around 3.5 mA) to charge an external  $V_{DD}$  capacitor until  $V_{DD}$  voltage exceeds the turn-on threshold voltage ( $V_{DD-ON}$ ). For lower power consumption, the HV startup circuit shuts down during normal operation. The external  $V_{DD}$  capacitor and auxiliary winding maintain the  $V_{DD}$  voltage and provide operating current to controller.

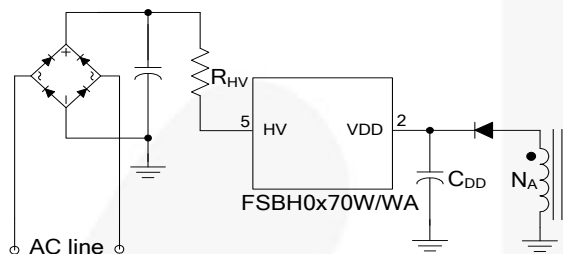

Figure 22. Startup Circuit

### Slope Compensation

The FSBH-series is designed for flyback power converters. The peak-current-mode control is used to optimize system performance. Slope compensation is added to reduce current loop gain and improve power system stability. The FSBH-series has a built-in, synchronized, positive slope for each switching cycle.

### Soft-Start

The FSBH-series has an internal soft-start circuit that reduces the SenseFET switching current during power system startup. The characteristic curve of soft-start time versus  $V_{LMT}$  level is shown in Figure 23. The  $V_{LMT}$  level rises in six steps. By doing so, the power system can smoothly build up the rated output voltage and effectively reduce voltage stress on the PWM switch and output diode.

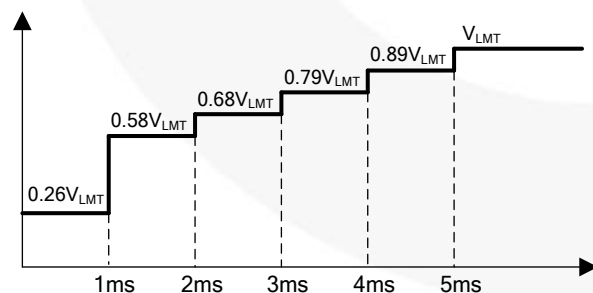

Figure 23. Soft-Start Function

### Brown-In/Out Function

FSBH0170W/0270W has a built-in internal brown-in/out protection comparator monitoring voltage of the VIN pin. Figure 24 shows a resistive divider with low-pass filtering for line-voltage detection on the VIN pin.

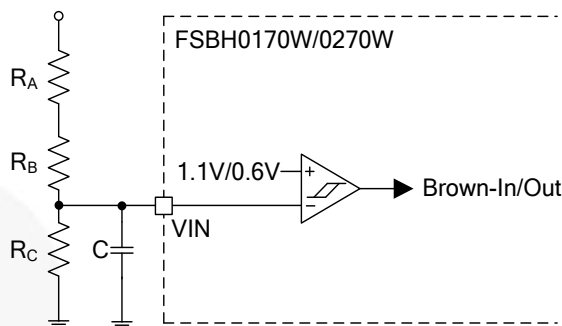

Figure 24. Brown-In/Out Function on VIN Pin

Once the VIN pin voltage is lower than 0.6 V and lasts for 500 ms, the PWM gate is disabled to protect the system from over current. FSBH0170W/0270W starts up as  $V_{IN}$  increases above 1.1 V. Because the divider resistors of the VIN pin are connected behind the bridge, the ratio calculations for brownout in PFC and non-PFC system are different, as shown in Figure 25. The formulas are provided in the following equations:

Brownout with PFC:

$$\frac{R_C}{R_A + R_B + R_C} \cdot \sqrt{2} V_{AC\_OUT} \cdot \frac{2}{\pi} = 0.6 \quad (1)$$

Brownout with non-PFC:

$$\frac{R_C}{R_A + R_B + R_C} \cdot \sqrt{2} V_{AC\_OUT} = 0.6 \quad (2)$$

Brown-in level is determined by:

$$V_{AC\_IN} = \frac{1.1}{\sqrt{2}} \cdot \frac{R_A + R_B + R_C}{R_C} \quad (3)$$

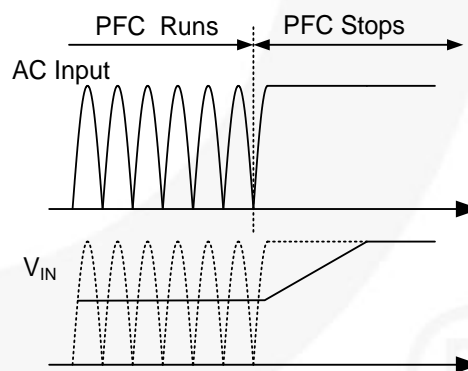

Figure 25.  $V_{IN}$  Level According to PFC Operation

### Brown-In Function of FSBH0F70WA

The VIN pin functions are disabled from FSBH0F70WA which still exist brown-in protection in  $V_{DD}$  pin. There is a discharge current internal from  $V_{DD}$  to ground during startup. The HV source current must be larger than  $I_{DD-ST}$  to charge the capacitor of  $V_{DD}$ . The brown-in level can be determined by  $R_{HV}$  according to the equation:

$$R_{HV} = \frac{\sqrt{2} V_{AC} - 12}{I_{DD-ST}} \quad (4)$$

## Green-Mode Operation

The FSBH-series uses feedback voltage ( $V_{FB}$ ) as an indicator of the output load and modulates the PWM frequency, as shown in Figure 26, such that the switching frequency decreases as load decreases. In heavy-load conditions, the switching frequency is 100 kHz. Once  $V_{FB}$  decreases below  $V_{FB-N}$  (2.5 V), the PWM frequency starts to linearly decrease from 100 kHz to 18 kHz to reduce switching losses. As  $V_{FB}$  decreases below  $V_{FB-G}$  (2.0 V), the switching frequency is fixed at 18 kHz and the FSBH-series enters “deep” green mode to reduce the standby power consumption.

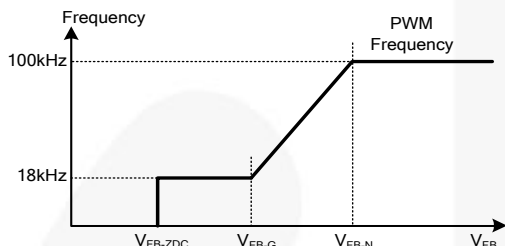

**Figure 26. PWM Frequency**

As  $V_{FB}$  decreases below  $V_{FB-ZDC}$  (1.6 V), the FSBH-series enters burst-mode operation. When  $V_{FB}$  drops below  $V_{FB-ZDC}$ , FSBH-series stops switching and the output voltage starts to drop, which causes the feedback voltage to rise. Once  $V_{FB}$  rises above  $V_{FB-ZDC}$ , switching resumes. Burst mode alternately enables and disables switching, thereby reducing switching loss to improve power saving, as shown in Figure 27.

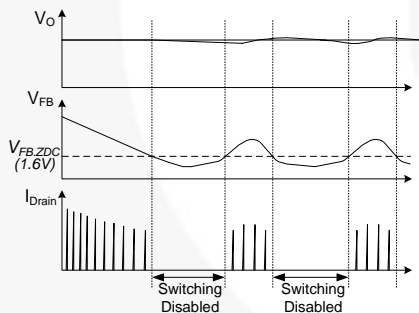

**Figure 27. Burst-Mode Operation**

## H/L Line Over-Power Compensation

To limit the output power of the converter constantly, high/low line over-power compensation is included. Sensing the converter input voltage through the  $V_{IN}$  pin, the high/low line compensation function generates a relative peak-current-limit threshold voltage for constant power control, as shown in Figure 28.

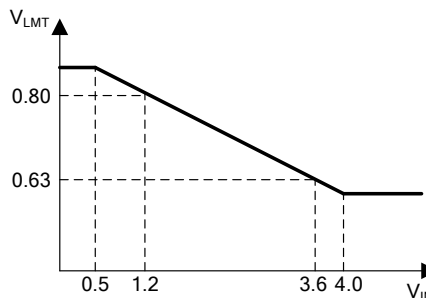

**Figure 28. Constant Power Control**

## Protections

The FSBH-series provides full protection functions to prevent the power supply and the load from being damaged. The protection features include:

### Open-Loop / Overload Protection (OLP)

When the upper branch of the voltage divider for the shunt regulator (KA431 shown) is broken, as shown in Figure 29, or over current or output short occurs, there is no current flowing through the opto-coupler transistor, which pulls the feedback voltage up to 6 V.

When feedback voltage is above 4.6 V for longer than 56 ms, OLP is triggered. This protection is also triggered when the SMPS output drops below the nominal value longer than 56 ms due to the overload condition.

### V<sub>DD</sub> Over-Voltage Protection (OVP)

$V_{DD}$  over-voltage protection prevents IC damage caused by over voltage on the  $V_{DD}$  pin. The OVP is triggered when  $V_{DD}$  voltage reaches 28 V. Debounce time (typically 130  $\mu$ s) prevents false trigger by switching noise.

### Over-Temperature Protection (OTP)

The SenseFET and the control IC are integrated, making it easier to detect the temperature of the SenseFET. As the temperature exceeds approximately 142°C, thermal shutdown is activated.

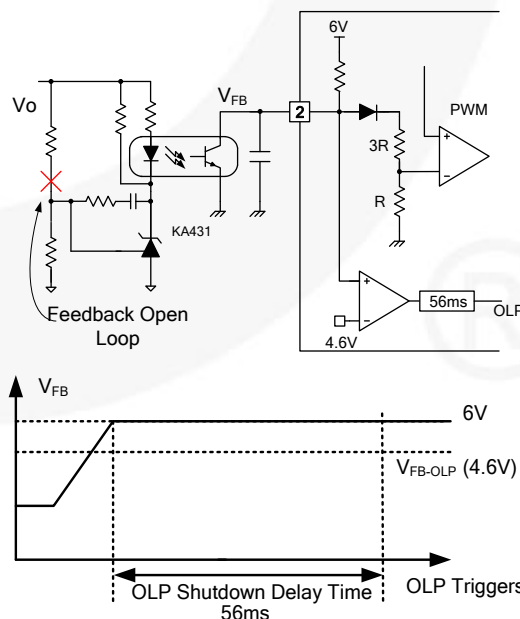

**Figure 29. OLP Operation**

## Physical Dimensions

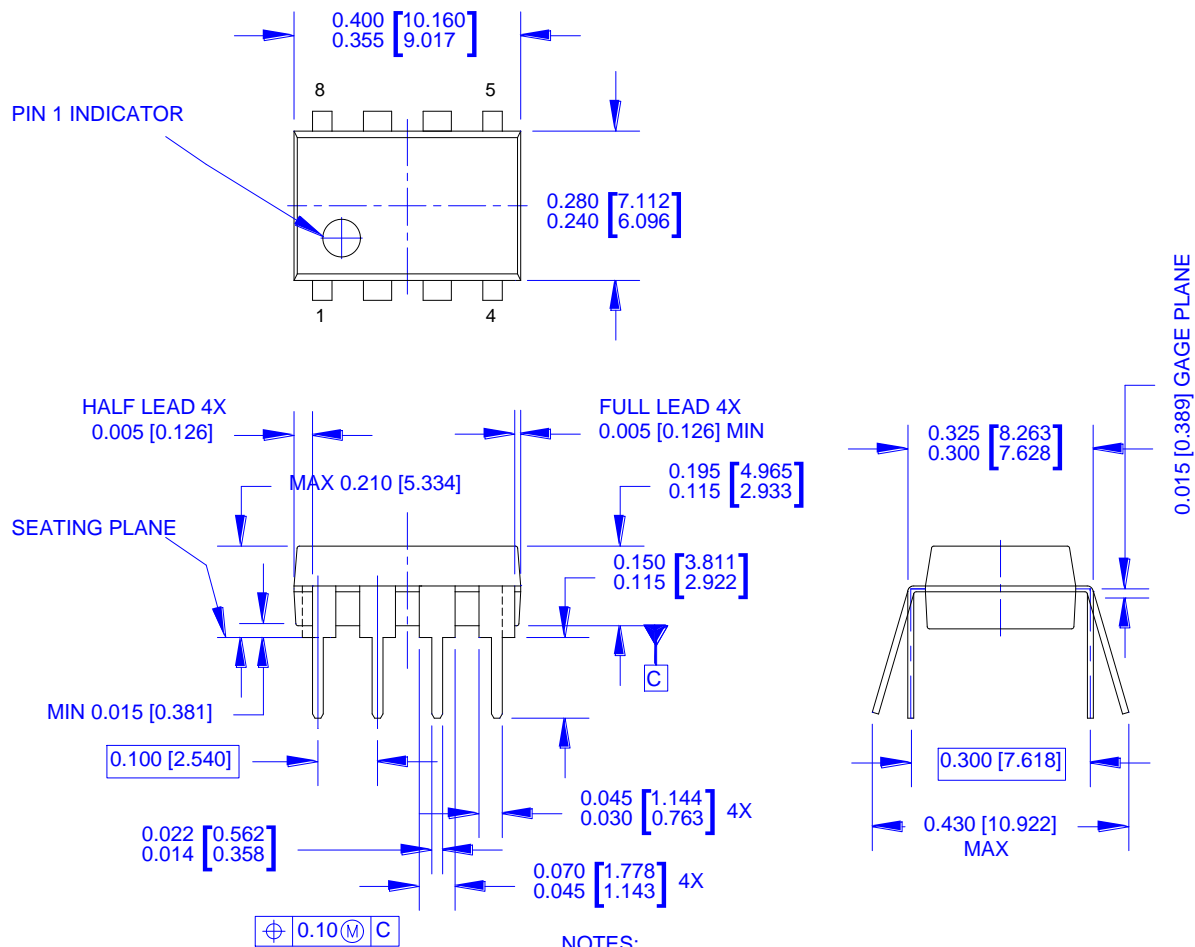

- NOTES:**
- A) THIS PACKAGE CONFORMS TO JEDEC MS-001 VARIATION BA
  - B) CONTROLLING DIMS ARE IN INCHES
  - C) DIMENSIONS ARE EXCLUSIVE OF BURRS, MOLD FLASH, AND TIE BAR EXTRUSIONS.
  - D) DIMENSIONS AND TOLERANCES PER ASME Y14.5M-1982
  - E) DRAWING FILENAME AND REVISION: MKT-N08MREV1.

**Figure 30. 8-Pin Dual In-Line Package (DIP)**

Package drawings are provided as a service to customers considering Fairchild components. Drawings may change in any manner without notice. Please note the revision and/or date on the drawing and contact a Fairchild Semiconductor representative to verify or obtain the most recent revision. Package specifications do not expand the terms of Fairchild's worldwide terms and conditions, specifically the warranty therein, which covers Fairchild products.

Always visit Fairchild Semiconductor's online packaging area for the most recent package drawings:  
<http://www.fairchildsemi.com/packaging/>.



## TRADEMARKS

The following includes registered and unregistered trademarks and service marks, owned by Fairchild Semiconductor and/or its global subsidiaries, and is not intended to be an exhaustive list of all such trademarks.

2Cool™	FPST™		Sync-Lock™
AccuPower™	F-PFS™		
AX-CAP®*	FRFET®	PowerTrench®	TinyBoost™
BitSiC™	Global Power Resource™	PowerXS™	TinyBuck™
Build it Now™	GreenBridge™	Programmable Active Droop™	TinyCalc™
CorePLUS™	Green FPS™	QFET®	TinyLogic®
CorePOWER™	Green FPS™ e-Series™	QST™	TINYOPTO™
CROSSVOLT™	Gmax™	Quiet Series™	TinyPower™
CTL™	GTO™	RapidConfigure™	TinyPWM™
Current Transfer Logic™	IntelliMAX™		TinyWire™
DEUXPEED®	ISOPLANAR™	Saving our world, 1mW/W/kW at a time™	TranSiC™
Dual Cool™	Making Small Speakers Sound Louder and Better™	SignalWise™	TriFault Detect™
EcoSPARK®	MegaBuck™	SmartMax™	TRUECURRENT®*
EfficientMax™	MICROCOUPLER™	SMART START™	µSerDes™
ESBC™	MicroFET™	Solutions for Your Success™	
	MicroPak™	SPM®	UHC®
Fairchild®	MicroPak2™	STEALTH™	Ultra FRFET™
Fairchild Semiconductor®	MillerDrive™	SuperFET®	UniFET™
FACT Quiet Series™	MotionMax™	SuperSOT™-3	VCC™
FACT®	mWSaver™	SuperSOT™-6	VisualMax™
FAST®	OptoHi™	SuperSOT™-8	VoltagePlus™
FastvCore™	OPTOLOGIC®	SupreMOS®	XST™
FETBench™	OPTOPLANAR®	SyncFET™	

\* Trademarks of System General Corporation, used under license by Fairchild Semiconductor.

## DISCLAIMER

FAIRCHILD SEMICONDUCTOR RESERVES THE RIGHT TO MAKE CHANGES WITHOUT FURTHER NOTICE TO ANY PRODUCTS HEREIN TO IMPROVE RELIABILITY, FUNCTION, OR DESIGN. FAIRCHILD DOES NOT ASSUME ANY LIABILITY ARISING OUT OF THE APPLICATION OR USE OF ANY PRODUCT OR CIRCUIT DESCRIBED HEREIN, NEITHER DOES IT CONVEY ANY LICENSE UNDER ITS PATENT RIGHTS, NOR THE RIGHTS OF OTHERS. THESE SPECIFICATIONS DO NOT EXPAND THE TERMS OF FAIRCHILD'S WORLDWIDE TERMS AND CONDITIONS, SPECIFICALLY THE WARRANTY THEREIN, WHICH COVERS THESE PRODUCTS.

## LIFE SUPPORT POLICY

FAIRCHILD'S PRODUCTS ARE NOT AUTHORIZED FOR USE AS CRITICAL COMPONENTS IN LIFE SUPPORT DEVICES OR SYSTEMS WITHOUT THE EXPRESS WRITTEN APPROVAL OF FAIRCHILD SEMICONDUCTOR CORPORATION.

As used herein:

1. Life support devices or systems are devices or systems which, (a) are intended for surgical implant into the body or (b) support or sustain life, and (c) whose failure to perform when properly used in accordance with instructions for use provided in the labeling, can be reasonably expected to result in a significant injury of the user.
2. A critical component in any component of a life support device, or system whose failure to perform can be reasonably expected to cause the failure of the life support device or system, or to affect its safety or effectiveness.

## ANTI-COUNTERFEITING POLICY

Fairchild Semiconductor Corporation's Anti-Counterfeiting Policy. Fairchild's Anti-Counterfeiting Policy is also stated on our external website, [www.fairchildsemi.com](http://www.fairchildsemi.com), under Sales Support.

Counterfeiting of semiconductor parts is a growing problem in the industry. All manufacturers of semiconductor products are experiencing counterfeiting of their parts. Customers who inadvertently purchase counterfeit parts experience many problems such as loss of brand reputation, substandard performance, failed applications, and increased cost of production and manufacturing delays. Fairchild is taking strong measures to protect ourselves and our customers from the proliferation of counterfeit parts. Fairchild strongly encourages customers to purchase Fairchild parts either directly from Fairchild or from Authorized Fairchild Distributors who are listed by country on our web page cited above. Products customers buy either from Fairchild directly or from Authorized Fairchild Distributors are genuine parts, have full traceability, meet Fairchild's quality standards for handling and storage and provide access to Fairchild's full range of up-to-date technical and product information. Fairchild and our Authorized Distributors will stand behind all warranties and will appropriately address any warranty issues that may arise. Fairchild will not provide any warranty coverage or other assistance for parts bought from Unauthorized Sources. Fairchild is committed to combat this global problem and encourage our customers to do their part in stopping this practice by buying direct or from authorized distributors.

## PRODUCT STATUS DEFINITIONS

### Definition of Terms

Datasheet Identification	Product Status	Definition
Advance Information	Formative / In Design	Datasheet contains the design specifications for product development. Specifications may change in any manner without notice.
Preliminary	First Production	Datasheet contains preliminary data; supplementary data will be published at a later date. Fairchild Semiconductor reserves the right to make changes at any time without notice to improve design.
No Identification Needed	Full Production	Datasheet contains final specifications. Fairchild Semiconductor reserves the right to make changes at any time without notice to improve the design.
Obsolete	Not In Production	Datasheet contains specifications on a product that is discontinued by Fairchild Semiconductor. The datasheet is for reference information only.

Rev. I64



ON Semiconductor and  are trademarks of Semiconductor Components Industries, LLC dba ON Semiconductor or its subsidiaries in the United States and/or other countries. ON Semiconductor owns the rights to a number of patents, trademarks, copyrights, trade secrets, and other intellectual property. A listing of ON Semiconductor's product/patent coverage may be accessed at [www.onsemi.com/site/pdf/Patent-Marking.pdf](http://www.onsemi.com/site/pdf/Patent-Marking.pdf). ON Semiconductor reserves the right to make changes without further notice to any products herein. ON Semiconductor makes no warranty, representation or guarantee regarding the suitability of its products for any particular purpose, nor does ON Semiconductor assume any liability arising out of the application or use of any product or circuit, and specifically disclaims any and all liability, including without limitation special, consequential or incidental damages. Buyer is responsible for its products and applications using ON Semiconductor products, including compliance with all laws, regulations and safety requirements or standards, regardless of any support or applications information provided by ON Semiconductor. "Typical" parameters which may be provided in ON Semiconductor data sheets and/or specifications can and do vary in different applications and actual performance may vary over time. All operating parameters, including "Typicals" must be validated for each customer application by customer's technical experts. ON Semiconductor does not convey any license under its patent rights nor the rights of others. ON Semiconductor products are not designed, intended, or authorized for use as a critical component in life support systems or any FDA Class 3 medical devices or medical devices with a same or similar classification in a foreign jurisdiction or any devices intended for implantation in the human body. Should Buyer purchase or use ON Semiconductor products for any such unintended or unauthorized application, Buyer shall indemnify and hold ON Semiconductor and its officers, employees, subsidiaries, affiliates, and distributors harmless against all claims, costs, damages, and expenses, and reasonable attorney fees arising out of, directly or indirectly, any claim of personal injury or death associated with such unintended or unauthorized use, even if such claim alleges that ON Semiconductor was negligent regarding the design or manufacture of the part. ON Semiconductor is an Equal Opportunity/Affirmative Action Employer. This literature is subject to all applicable copyright laws and is not for resale in any manner.

## PUBLICATION ORDERING INFORMATION

### LITERATURE FULFILLMENT:

Literature Distribution Center for ON Semiconductor  
19521 E. 32nd Pkwy, Aurora, Colorado 80011 USA  
**Phone:** 303-675-2175 or 800-344-3860 Toll Free USA/Canada  
**Fax:** 303-675-2176 or 800-344-3867 Toll Free USA/Canada  
**Email:** [orderlit@onsemi.com](mailto:orderlit@onsemi.com)

**N. American Technical Support:** 800-282-9855 Toll Free  
USA/Canada  
**Europe, Middle East and Africa Technical Support:**  
Phone: 421 33 790 2910  
**Japan Customer Focus Center**  
Phone: 81-3-5817-1050

**ON Semiconductor Website:** [www.onsemi.com](http://www.onsemi.com)  
**Order Literature:** <http://www.onsemi.com/orderlit>  
For additional information, please contact your local  
Sales Representative