



Is Now Part of



ON Semiconductor®

To learn more about ON Semiconductor, please visit our website at
www.onsemi.com

Please note: As part of the Fairchild Semiconductor integration, some of the Fairchild orderable part numbers will need to change in order to meet ON Semiconductor's system requirements. Since the ON Semiconductor product management systems do not have the ability to manage part nomenclature that utilizes an underscore (_), the underscore (_) in the Fairchild part numbers will be changed to a dash (-). This document may contain device numbers with an underscore (_). Please check the ON Semiconductor website to verify the updated device numbers. The most current and up-to-date ordering information can be found at www.onsemi.com. Please email any questions regarding the system integration to Fairchild_questions@onsemi.com.

ON Semiconductor and the ON Semiconductor logo are trademarks of Semiconductor Components Industries, LLC dba ON Semiconductor or its subsidiaries in the United States and/or other countries. ON Semiconductor owns the rights to a number of patents, trademarks, copyrights, trade secrets, and other intellectual property. A listing of ON Semiconductor's product/patent coverage may be accessed at www.onsemi.com/site/pdf/Patent-Marking.pdf. ON Semiconductor reserves the right to make changes without further notice to any products herein. ON Semiconductor makes no warranty, representation or guarantee regarding the suitability of its products for any particular purpose, nor does ON Semiconductor assume any liability arising out of the application or use of any product or circuit, and specifically disclaims any and all liability, including without limitation special, consequential or incidental damages. Buyer is responsible for its products and applications using ON Semiconductor products, including compliance with all laws, regulations and safety requirements or standards, regardless of any support or applications information provided by ON Semiconductor. "Typical" parameters which may be provided in ON Semiconductor data sheets and/or specifications can and do vary in different applications and actual performance may vary over time. All operating parameters, including "Typicals" must be validated for each customer application by customer's technical experts. ON Semiconductor does not convey any license under its patent rights nor the rights of others. ON Semiconductor products are not designed, intended, or authorized for use as a critical component in life support systems or any FDA Class 3 medical devices or medical devices with a same or similar classification in a foreign jurisdiction or any devices intended for implantation in the human body. Should Buyer purchase or use ON Semiconductor products for any such unintended or unauthorized application, Buyer shall indemnify and hold ON Semiconductor and its officers, employees, subsidiaries, affiliates, and distributors harmless against all claims, costs, damages, and expenses, and reasonable attorney fees arising out of, directly or indirectly, any claim of personal injury or death associated with such unintended or unauthorized use, even if such claim alleges that ON Semiconductor was negligent regarding the design or manufacture of the part. ON Semiconductor is an Equal Opportunity/Affirmative Action Employer. This literature is subject to all applicable copyright laws and is not for resale in any manner.



FPF2498

Adjustable OVP with 28 V Input OVT Load Switch

Features

Function	Advanced Load Switch
Input	3.5 – 12 V
Features	28 V Absolute Ratings on VIN 1.7 A Maximum Continuous Current Capability 80 mΩ R _{ON} Typical Over-Voltage Protection (OVP) Over-Current Protection (OCP) Thermal Shutdown Under-Voltage Lockout (UVLO) Reverse Current Blocking (RCB)
ESD	15 kV IEC 61000-4-2 Air Gap
Operating Temperature Range	-40 to +85°C
Package	6-Ball WLCSP (1.05 x 1.3 x 0.625 mm, 0.4 mm Pitch)
Ordering Information	FPF2498BUCX
Top Mark	TK

Description

The FPF2498 advanced load-management switch targets applications requiring a highly integrated solution. It disconnects loads powered from the DC power rail (<12 V) with stringent off-state current targets and high load capacitances (<100 μF). The FPF2498 consists of a slew-rate controlled low-impedance MOSFET switch. FPF2498 has over-voltage protection and over-temperature protection.

Applications

- Cellular Phones, Smart Phones
- Tablets

Related Resources

- FPF2498 Evaluation Board*

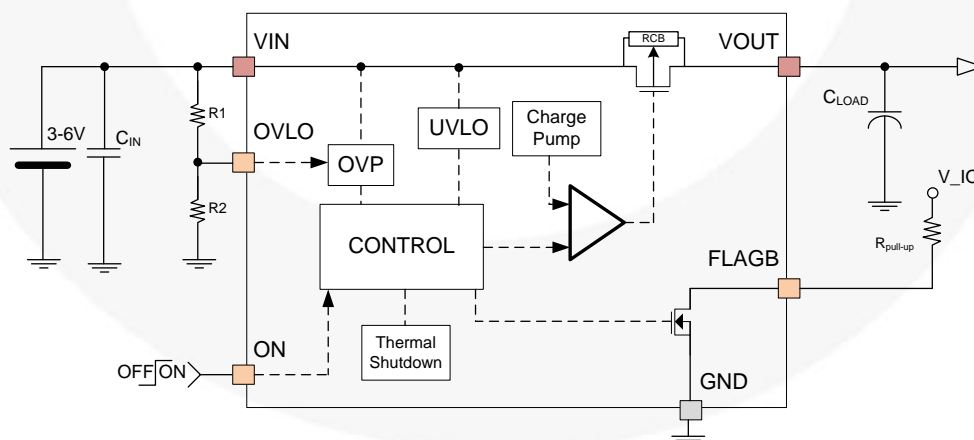

Figure 1. Block Diagram and Typical Application

Note:

1. Recommend C_{LOAD} value be larger than 2.2 μF.

Pin Configuration

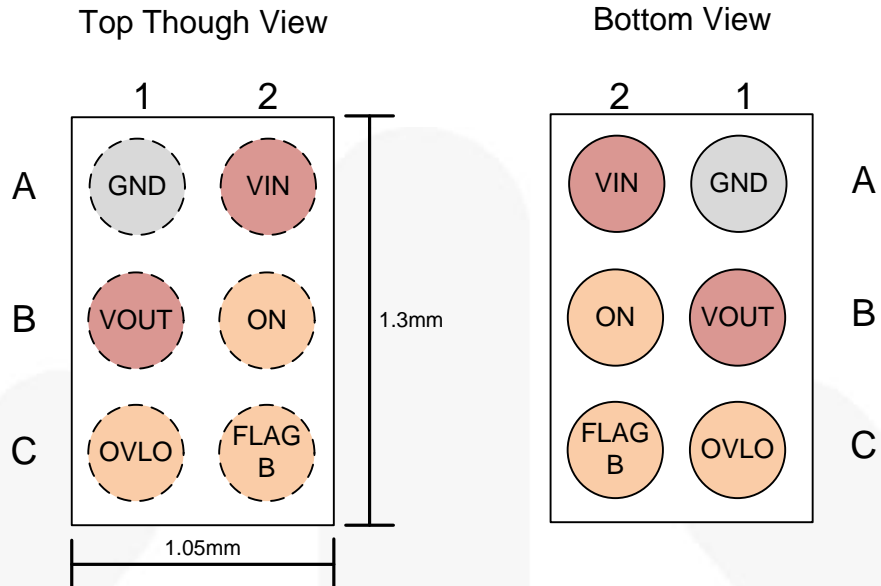

Figure 2. Pin Assignments

Pin Map

Name	Pin #	Type	Default State	Description	
VIN	A2	Input	N/A	Input voltage path	
VOUT	B1	Output	N/A	Output voltage path	
ON	B2	Input	LOW	On / Off control of device	V_{IH} =HIGH Enabled
					V_{IL} =LOW Disabled
OVLO	C1	Input		OVP Adjustment set by R1 and R2 and is compared to $1.2 V - V_{IN} \times R2 / (R1+R2) > 1.2 V$	
FLAGB	C2	Open-Drain Output	High-Z	Indicates a OVP / OCP / OTP fault	LOW / GND Active – Indicates: OVP (over 6.5 V at 3 – 6 V) OCP (over 2 A) OTP (over 150°C)
					HIGH / V _{IO} Normal Operation
GND	A1	GND	GND	Device ground	

Absolute Maximum Ratings

Stresses exceeding the absolute maximum ratings may damage the device. The device may not function or be operable above the recommended operating conditions and stressing the parts to these levels is not recommended. In addition, extended exposure to stresses above the recommended operating conditions may affect device reliability. The absolute maximum ratings are stress ratings only.

Symbol	Parameters	Min.	Max.	Unit
V_{PIN}	Voltage on VIN to GND, VIN to VOUT, OVLO Pins	-0.3	28.0	V
	Voltage on ON, FLAGB Pins	-0.3	6.0	
	Voltage on VOUT to GND Pins	-0.3	20.0	
I_{SW}	Maximum Switch Current		1.75	A
t_{PD}	Total Power Dissipation at $T_A=25^\circ\text{C}$		1	W
T_J	Operating Junction Temperature	-40	+150	$^\circ\text{C}$
T_{STG}	Storage Junction Temperature	-65	+150	$^\circ\text{C}$
Θ_{JA}	Thermal Resistance, Junction-to-Ambient (1-inch Square Pad of 2 oz. Copper)		95 ⁽²⁾	$^\circ\text{C/W}$
			110 ⁽³⁾	
ESD	Electrostatic Discharge Capability	Human Body Model, ANSI / ESDA / JEDEC JS-001-2012	3	kV
		Charged Device Model, JESD22-C101	2	
	IEC61000-4-2 System Level	Air Discharge (V_{IN} , V_{ON} , V_{OUT} to GND)	15	
		Contact Discharge (V_{IN} , V_{ON} , V_{OUT} to GND)	8	

Notes:

- Measured using 2S2P JEDEC std. PCB.
- Measured using 2S2P JEDEC PCB cold plate method.

Recommended Operating Conditions

The Recommended Operating Conditions table defines the conditions for actual device operation. Recommended operating conditions are specified to ensure optimal performance to the datasheet specifications. Fairchild does not recommend exceeding them or designing to Absolute Maximum Ratings.

Symbol	Parameters	Min.	Max.	Unit
V_{IN}	Supply Voltage	3.5	12.0	V
I_{SW}	Maximum Continuous Switch Current ⁽⁴⁾		1.7	A
T_A	Ambient Operating Temperature	-40	85	$^\circ\text{C}$

Note:

- Maximum Junction Temperature = 85°C

Electrical Characteristics

Unless otherwise noted; $V_{IN}=3.5$ to 5.5 V, $T_A=-40$ to $+85^\circ\text{C}$; typical values are at $V_{IN}=5$ V and $T_A=25^\circ\text{C}$.

Symbol	Parameter	Conditions	Min.	Typ.	Max.	Unit
Basic Operation						
$I_{SD(OFF)}$	Shutdown Current	$V_{IN}=5.5$ V, $V_{OUT}=0$ V, $V_{ON}=GND$		0.4	3.0	μA
I_Q	Quiescent Current	$V_{IN}=5.5$ V, $V_{OUT}=Floating$, $I_{OUT}=0$ mA		90	125	μA
R_{ON}	On Resistance	$V_{IN}=3.7$ V, $I_{OUT}=200$ mA		90		m Ω
		$V_{IN}=5.0$ V, $I_{OUT}=200$ mA		80	95 ⁽⁵⁾	
		$V_{IN}=9$ V, $I_{OUT}=200$ mA				
		$V_{IN}=12$ V, $I_{OUT}=200$ mA				
V_{IH}	ON Input Logic HIGH Voltage	$V_{IN}=3.5$ V to 5.5 V	1.15			V
V_{IL}	ON Input Logic LOW Voltage	$V_{IN}=3.5$ V to 5.5 V			0.65	V
V_{OL_FLAG}	FLAGB Output Logic LOW Voltage	$V_{IN}=5$ V, $I_{SINK}=1$ mA		0.10	0.20	V
I_{FLAGB_LK}	FLAGB Output HIGH Leakage Current	$V_{IN}=5$ V, Switch On			0.5	μA
RPD	Pull-Down Resistance on ON Pin	$V_{IN}=5$ V, $OVLO=GND$		3		M Ω
Over-Voltage Protection						
V_{OV_TRIP}	Default Input OVP Lockout	V_{IN} Rising Threshold $OVLO=GND$	6.2	6.5	6.8	V
		V_{IN} Falling Threshold $OVLO=GND$		6.2		
V_{OVLO_SEL}	Voltage threshold for $OVLO$ selection	$V_{IN}=3.5$ V to 5.5 V, $OVLO=GND$		0.3		V
V_{OVP_HYS}	Input OVP Hysteresis	V_{IN} Falling Threshold $OVLO=External$ Setting		0.3		V
V_{OVLO_TH}	$OVLO$ Set Threshold	$V_{IN}=3.5$ to V_{OVLO}		1.20		V
t_{OVP}	Response Time	$I_{OUT}=0.5$ A, $C_L=0$ μF , $T_A=25^\circ\text{C}$, $V_{IN}=6$ V to 7 V		0.5	1	μs
V_{UVLO}	Under-Voltage Lockout	V_{IN} Rising		3.2		V
		V_{IN} Falling		3.0		
V_{UVLO_HYS}	UVLO Hysteresis			200		mV
I_{RCB}	RCB Current	$V_{ON}=0$ V, $V_{OUT}=5.5$ V, $V_{IN}=0$ V		2	5	μA
TSD	Thermal Shutdown	Shutdown Threshold		150		$^\circ\text{C}$
		Return from Shutdown		130		
		Hysteresis		20		
Over-Current Protection						
I_{OCP}	Over-Current Protection Trip Point	$I_{SW} > I_{OCP}$		2		A
Dynamic Characteristics						
t_{DON}	Turn-On Delay ⁽⁷⁾	$V_{IN}=5$ V, $R_L=100$ Ω , $C_L=10$ μF , $T_A=25^\circ\text{C}$		4.3		ms
t_R	V_{OUT} Rise Time ⁽⁷⁾			3.0		ms
t_{ON}	Turn-On Time ⁽⁸⁾			7.3		ms
t_{DOFF}	Turn-Off Delay ^(6,7)			600		μs
t_F	V_{OUT} Fall Time ^(6,7)			2.0		ms
t_{OFF}	Turn-Off Time ^(6,9)			2.5		ms
t_{READY}	Time for Device Ready for Large Load Current ⁽¹⁰⁾	$C_L=10$ μF		5		ms

Continued on the following page...

Electrical Characteristics

Unless otherwise noted; $V_{IN}=3.5$ to 5.5 V, $T_A=-40$ to $+85^\circ\text{C}$; typical values are at $V_{IN}=5$ V and $T_A=25^\circ\text{C}$.

Symbol	Parameter	Conditions	Min.	Typ.	Max.	Unit
t_{RESTART}	Over-Current Blanking Time ⁽⁶⁾	$V_{IN}=5$ V $I_{OUT} \geq 1.7$ A		64		ms
t_{OCP}	Over-Current Response Time ⁽⁶⁾	Moderate Over-Current Condition; $I_{OUT} \geq I_{LIM}$ $V_{OUT} \leq V_{IN}$		4		μs
t_{HOCP}	Hard Over-Current Response Time	Moderate Over-Current Condition; $I_{OUT} \geq I_{LIM}$ $V_{OUT} \leq 0$ V		3		μs
$t_{\text{FLAG_Release}}$	Over-Current/Voltage/Temp. Flag Release Time ⁽⁶⁾	Time for Flag to Release when Fault Condition Removed		100		ms

Notes:

5. $T_A=25^\circ\text{C}$.
6. This parameter is guaranteed by design and characterization; not production tested.
7. $t_{\text{DON}}/t_{\text{DOFF}}/t_{\text{R}}/t_{\text{F}}$ are defined in figure below.
8. $t_{\text{ON}}=t_{\text{R}} + t_{\text{DON}}$.
9. $t_{\text{OFF}}=t_{\text{F}} + t_{\text{DOFF}}$.
10. After t_{READY} , the device is ready for maximum DC current load condition.

Timing Diagram

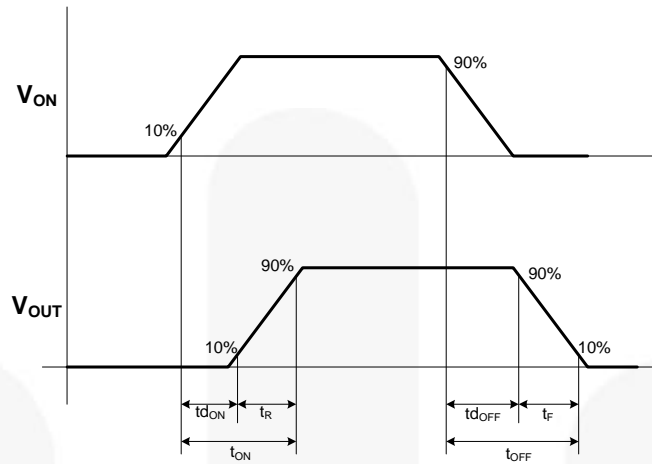

Figure 3. Timing Diagram

where:

- t_{DON} =Delay On Time;
- t_r = V_{OUT} Rise Time;
- t_{ON} =Turn-On Time;
- t_{DOFF} =Delay Off Time;
- t_f = V_{OUT} Fall Time; and
- t_{OFF} =Turn Off Time.

Device Fault Behavior Timing

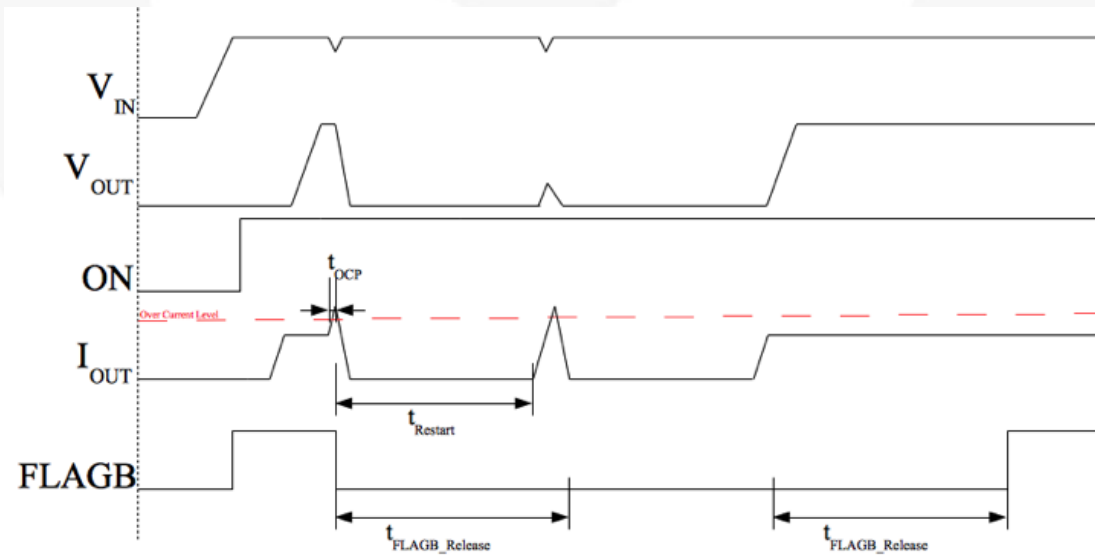

Figure 4. OCP Turn-Off Timing Diagram

Operation and Application Description

Input Capacitor

To limit the voltage drop on the input supply caused by transient inrush current when the switch turns on into discharge load capacitor; a capacitor must be placed between the VIN and GND pins. A high-value C_{IN} capacitor can be used to reduce the voltage drop in high-current applications.

Output Capacitor

An output capacitor should be placed between the VOUT and GND pins. This capacitor prevents parasitic board inductance from forcing VOUT below ground when the switch is on. This capacitor also prevents reverse inrush current from creating a voltage spike that could damage the device in the case of a VOUT short.

Fault Reporting

Upon the detection of an over-voltage, over-current, or over-temperature condition, the FLAGB signals the fault by activating LOW.

Under-Voltage Lockout (UVLO)

The under-voltage lockout turns the switch off if the input voltage drops below the lockout threshold. With the ON pin active, the input voltage rising above the UVLO threshold releases the lockout and enables the switch.

Over-Voltage Lockout (OVLO)

The OVLO pin sets the over-voltage lockout trip point with a resistor-divider network. OVLO adjustment is set by R1 and R2 and is compared to $1.2 V - V_{IN} \times R2 / (R1+R2) > 1.2 V$. when $V_{IN} > V_{OVLO}$ the switch turns off to ensure protection to devices connected to VOUT. A 1 MΩ or larger resistor is recommended on R1 to reduce standby power consumption. To use the default values of 5.8 V for V_{OVLO} , connect the OVLO pin directly to GND.

Package Specific Dimensions

D	E	X	Y
1.300±0.030	1.050±0.030	0.325	0.250

Reverse-Current Blocking (RCB)

The reverse-current blocking feature protects the input source against current flow from output to input. When the load switch is OFF, no current flows from the output to input.

Thermal Shutdown (TSD)

Thermal shutdown protects the die from internally or externally generated excessive temperature. During an over-temperature condition, the switch is turned off. The switch automatically turns on again if the temperature of the die drops below the threshold temperature.

Current Limit

The current limit ensures that the current flow through the switch doesn't exceed a maximum value, which can damage the device. If the current flow through the switch exceeds the trip point, the switch turns off and enters the blanking time. After the blanking time, the switch is re-enabled and checks if the fault still exists.

Board Layout

For best performance, all traces should be as short as possible. The input and output capacitors should be placed close to the device to minimize the effect that parasitic trace inductance may have on normal and short-circuit operation. Using wide traces for VIN, VOUT, GND minimizes parasitic electrical effects along with minimizing the case-to-ambient thermal impedance.

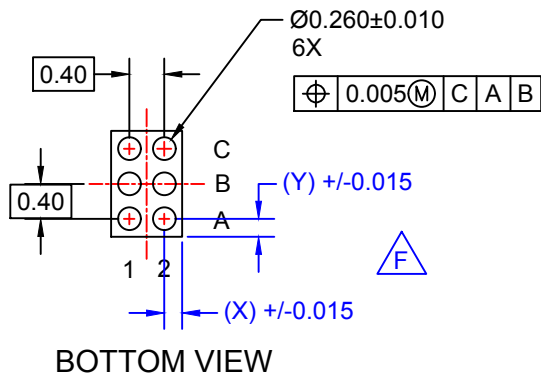
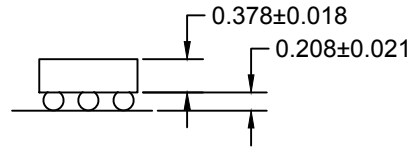
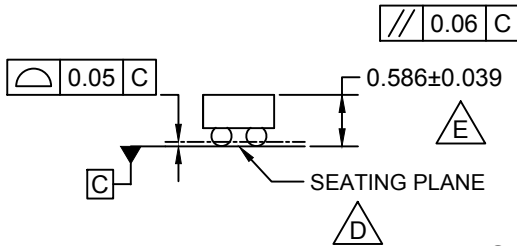
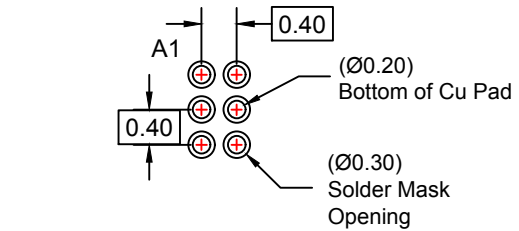
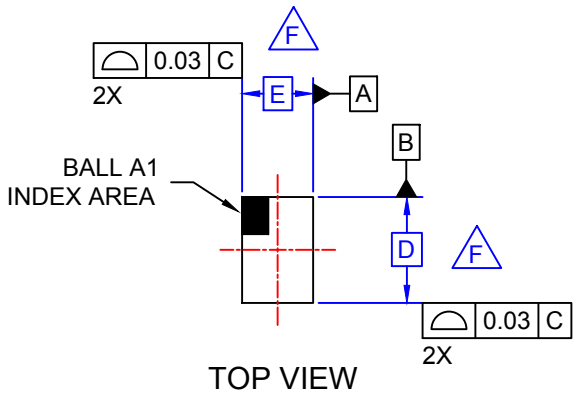

NOTES:

- A. NO JEDEC REGISTRATION APPLIES.
- B. DIMENSIONS ARE IN MILLIMETERS.
- C. DIMENSIONS AND TOLERANCES PER ASMEY14.5M, 2009.
- D.** DATUM C, THE SEATING PLANE IS DEFINED BY THE SPHERICAL CROWNS OF THE BALLS.
- E.** PACKAGE TYPICAL HEIGHT IS 586 MICRONS ±39 MICRONS (547-625 MICRONS).
- F.** FOR DIMENSIONS D, E, X, AND Y, SEE PRODUCT DATASHEET.
- G. DRAWING FILENAME: MKT-UC006ACrev6.



ON Semiconductor and  are trademarks of Semiconductor Components Industries, LLC dba ON Semiconductor or its subsidiaries in the United States and/or other countries. ON Semiconductor owns the rights to a number of patents, trademarks, copyrights, trade secrets, and other intellectual property. A listing of ON Semiconductor's product/patent coverage may be accessed at www.onsemi.com/site/pdf/Patent-Marking.pdf. ON Semiconductor reserves the right to make changes without further notice to any products herein. ON Semiconductor makes no warranty, representation or guarantee regarding the suitability of its products for any particular purpose, nor does ON Semiconductor assume any liability arising out of the application or use of any product or circuit, and specifically disclaims any and all liability, including without limitation special, consequential or incidental damages. Buyer is responsible for its products and applications using ON Semiconductor products, including compliance with all laws, regulations and safety requirements or standards, regardless of any support or applications information provided by ON Semiconductor. "Typical" parameters which may be provided in ON Semiconductor data sheets and/or specifications can and do vary in different applications and actual performance may vary over time. All operating parameters, including "Typicals" must be validated for each customer application by customer's technical experts. ON Semiconductor does not convey any license under its patent rights nor the rights of others. ON Semiconductor products are not designed, intended, or authorized for use as a critical component in life support systems or any FDA Class 3 medical devices or medical devices with a same or similar classification in a foreign jurisdiction or any devices intended for implantation in the human body. Should Buyer purchase or use ON Semiconductor products for any such unintended or unauthorized application, Buyer shall indemnify and hold ON Semiconductor and its officers, employees, subsidiaries, affiliates, and distributors harmless against all claims, costs, damages, and expenses, and reasonable attorney fees arising out of, directly or indirectly, any claim of personal injury or death associated with such unintended or unauthorized use, even if such claim alleges that ON Semiconductor was negligent regarding the design or manufacture of the part. ON Semiconductor is an Equal Opportunity/Affirmative Action Employer. This literature is subject to all applicable copyright laws and is not for resale in any manner.

PUBLICATION ORDERING INFORMATION

LITERATURE FULFILLMENT:

Literature Distribution Center for ON Semiconductor
19521 E. 32nd Pkwy, Aurora, Colorado 80011 USA
Phone: 303-675-2175 or 800-344-3860 Toll Free USA/Canada
Fax: 303-675-2176 or 800-344-3867 Toll Free USA/Canada
Email: orderlit@onsemi.com

N. American Technical Support: 800-282-9855 Toll Free
USA/Canada
Europe, Middle East and Africa Technical Support:
Phone: 421 33 790 2910
Japan Customer Focus Center
Phone: 81-3-5817-1050

ON Semiconductor Website: www.onsemi.com
Order Literature: <http://www.onsemi.com/orderlit>
For additional information, please contact your local
Sales Representative