

Low-Voltage 16-Bit Bidirectional Transceiver with 3.6 V Tolerant Inputs and Outputs

74ALVC16245

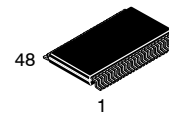

TSSOP48 12.5x6.1
CASE 948BQ

General Description

The ALVC16245 contains sixteen non-inverting bidirectional buffers with 3-STATE outputs and is intended for bus oriented applications. The device is byte controlled. Each byte has separate 3-STATE control inputs which can be shorted together for full 16-bit operation. The T/\bar{R} inputs determine the direction of data flow through the device. The \overline{OE} inputs disable both the A and B ports by placing them in a high impedance state.

The 74ALVC16245 is designed for low voltage (1.65 V to 3.6 V) V_{CC} applications with I/O capability up to 3.6 V.

The 74ALVC16245 is fabricated with an advanced CMOS technology to achieve high speed operation while maintaining low CMOS power dissipation.

Features

- 1.65 V – 3.6 V V_{CC} Supply Operation
- 3.6 V Tolerant Inputs and Outputs
- t_{PD}
 - ◆ 3.0 ns max for 3.0 V to 3.6 V V_{CC}
 - ◆ 3.5 ns max for 2.3 V to 2.7 V V_{CC}
 - ◆ 6.0 ns max for 1.65 V to 1.95 V V_{CC}
- Power-down High Impedance Inputs and Outputs
- Supports Live Insertion/Withdrawal*
- Uses Patented Noise/EMI Reduction Circuitry
- Latch-up conforms to JEDEC JED78
- ESD Performance:
 - ◆ Human Body Model >2000 V
 - ◆ Machine Model >200 V
- These Devices are Pb-Free, Halide Free and are RoHS Compliant

*To ensure the high-impedance state during power up or power down, \overline{OE} should be tied to V_{CC} through a pull-up resistor; the minimum value of the resistor is determined by the current-sourcing capability of the driver.

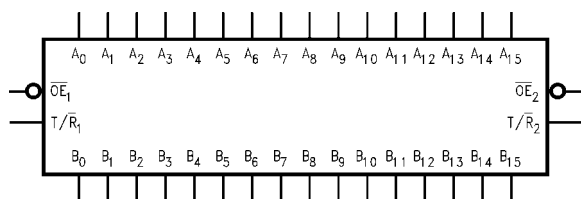
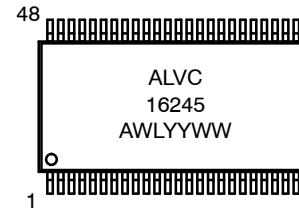

Figure 1. Logic Symbol

MARKING DIAGRAM



- A = Assembly Location
- WL = Wafer Lot
- YY = Year
- WW = Work Week

ORDERING INFORMATION

See detailed ordering and shipping information in the package dimensions section on page 5 of this data sheet.

74ALVC16245

Connection Diagram

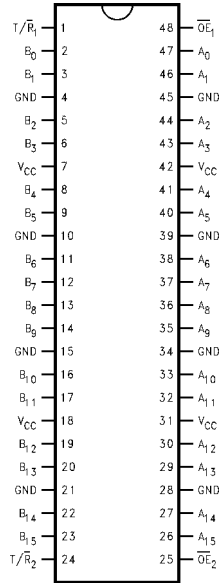

Figure 2. Pin Assignment of TSSOP

PIN DESCRIPTION

Pin Names	Description
\overline{OE}_n	Output Enable Input (Active LOW)
T/\overline{R}_n	Transmit/Receive Input
A_0-A_{15}	Side A Inputs of 3-STATE Outputs
B_0-B_{15}	Side B Inputs of 3-STATE Outputs
NC	No Connect

TRUTH TABLE

Inputs		Outputs
\overline{OE}_1	T/\overline{R}_1	
L	L	Bus B_0-B_7 Data to Bus A_0-A_7
L	H	Bus A_0-A_7 Data to Bus B_0-B_7
H	X	HIGH Z State on A_0-A_7 , B_0-B_7

Inputs		Outputs
\overline{OE}_2	T/\overline{R}_2	
L	L	Bus B_8-B_{15} Data to Bus A_8-A_{15}
L	H	Bus A_8-A_{15} Data to Bus B_8-B_{15}
H	X	HIGH Z State on A_8-A_{15} , B_8-B_{15}

H = HIGH Voltage Level

L = LOW Voltage Level

X = Immaterial (HIGH or LOW, inputs and I/O's may not float)

Z = High Impedance

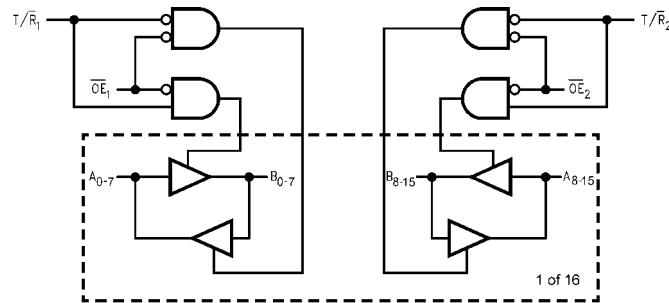

Figure 3. Logic Diagram

ABSOLUTE MAXIMUM RATINGS

Parameter	Symbol	Value	Unit
Supply Voltage	V_{CC}	-0.5 to +4.6	V
DC Input Voltage	V_I	-0.5 to +4.6	V
Output Voltage (Note 1)	V_O	-0.5 to $V_{CC} + 0.5$	V
DC Input Diode Current, $V_I < 0$ V	I_{IK}	-50	mA
DC Output Diode Current, $V_O < 0$ V	I_{OK}	-50	mA
DC Output Source/Sink Current	I_{OH}/I_{OL}	± 50	mA
DC V_{CC} or GND Current per Supply Pin	I_{CC} or GND	± 100	mA
Storage Temperature Range	T_{STG}	-65 to +150	$^{\circ}\text{C}$

Stresses exceeding those listed in the Maximum Ratings table may damage the device. If any of these limits are exceeded, device functionality should not be assumed, damage may occur and reliability may be affected.

1. I_O Absolute Maximum Rating must be observed.

RECOMMENDED OPERATING CONDITIONS (Note 2)

Symbol	Parameter	Min	Max	Unit
V_{CC}	Power Supply Operating Voltage	1.65	3.6	V
V_I	Input Voltage	0	V_{CC}	V
V_O	Output Voltage	0	V_{CC}	V
T_A	Free Air Operating Temperature	-40	85	$^{\circ}\text{C}$
$\Delta t/\Delta V$	Input Edge Rate, $V_{IN} = 0.8$ V to 2.0 V, $V_{CC} = 3.0$ V	0	10	ns/V

Functional operation above the stresses listed in the Recommended Operating Ranges is not implied. Extended exposure to stresses beyond the Recommended Operating Ranges limits may affect device reliability.

2. Floating or unused control inputs must be held HIGH or LOW.

DC ELECTRICAL CHARACTERISTICS

Symbol	Parameter	Conditions	V_{CC} (V)	Min	Max	Units
V_{IH}	HIGH Level Input Voltage		1.65 – 1.95	$0.65 \times V_{CC}$		V
			2.3 – 2.7	1.7		
			2.7 – 3.6	2.0		
V_{IL}	LOW Level Input Voltage		1.65 – 1.95		$0.35 \times V_{CC}$	V
			2.3 – 2.7		0.7	
			2.7 – 3.6		0.8	
V_{OH}	HIGH Level Output Voltage	$I_{OH} = -100 \mu\text{A}$	1.65 – 3.6	$V_{CC} - 0.2$		V
		$I_{OH} = -4 \text{ mA}$	1.65	1.2		
		$I_{OH} = -6 \text{ mA}$	2.3	2.0		
		$I_{OH} = -12 \text{ mA}$	2.3	1.7		
			2.7	2.2		
			3.0	2.4		
V_{OL}	LOW Level Output Voltage	$I_{OL} = 100 \mu\text{A}$	1.65 – 3.6		0.2	V
		$I_{OL} = 4 \text{ mA}$	1.65		0.45	
		$I_{OL} = 6 \text{ mA}$	2.3		0.4	
		$I_{OL} = 12 \text{ mA}$	2.3		0.7	
			2.7		0.4	
			3.0		0.55	
I_I	Input Leakage Current	$0 \leq V_I \leq 3.6$ V	3.6		± 5.0	μA
I_{OZ}	3-STATE Output Leakage	$0 \leq V_O \leq 3.6$ V	3.6		± 10	μA
I_{CC}	Quiescent Supply Current	$V_I = V_{CC}$ or GND, $I_O = 0$	3.6		40	μA
ΔI_{CC}	Increase in I_{CC} per Input	$V_{IH} = V_{CC} - 0.6$ V	3 – 3.6		750	μA

74ALVC16245

AC ELECTRICAL CHARACTERISTICS

Symbol	Parameter	$T_A = -40^{\circ}\text{C to } +85^{\circ}\text{C}, R_L = 500\ \Omega$								Units
		$C_L = 50\ \text{pF}$				$C_L = 30\ \text{pF}$				
		$V_{CC} = 3.3\ \text{V} \pm 0.3\ \text{V}$		$V_{CC} = 2.7\ \text{V}$		$V_{CC} = 2.5\ \text{V} \pm 0.2\ \text{V}$		$V_{CC} = 1.8\ \text{V} \pm 0.15\ \text{V}$		
		Min	Max	Min	Max	Min	Max	Min	Max	
t_{PHL}, t_{PLH}	Propagation Delay	1.3	3	1.5	3.5	1.0	3.0	1.5	6.0	ns
t_{PZL}, t_{PZH}	Output Enable Time	1.3	4.3	1.5	5.4	1.0	4.9	1.5	9.3	ns
t_{PLZ}, t_{PHZ}	Output Disable Time	1.3	4.2	1.5	4.7	1.0	4.2	1.5	7.6	ns

CAPACITANCE

Symbol	Parameter	Conditions	$T_A = +25^{\circ}\text{C}$		Units	
			V_{CC}	Typical		
C_{IN}	Input Capacitance	$V_I = 0\ \text{V or } V_{CC}$	3.3	6	pF	
C_{IO}	Input, Output Capacitance	$V_O = 0\ \text{V or } V_{CC}$	3.3	7	pF	
C_{PD}	Power Dissipation Capacitance	Outputs Enabled	$f = 10\ \text{MHz}, C_L = 50\ \text{pF}$	3.3	20	pF
				2.5	20	

74ALVC16245

AC Loading and Waveforms

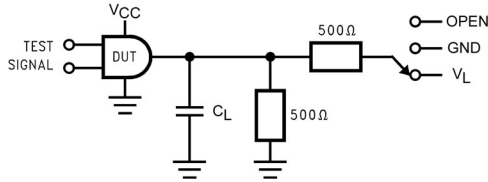

Figure 4. AC Test Circuit

Values for Figure 4

Test	Switch
t_{PLH} , t_{PHL}	Open
t_{PZL} , t_{PLZ}	V_L
t_{PZH} , t_{PHZ}	GND

VARIABLE MATRIX

(Input Characteristics: $f = 1 \text{ MHz}$; $t_r = t_f = 2 \text{ ns}$; $Z_0 = 50 \Omega$)

Symbol	V_{CC}			
	$3.3 \text{ V} \pm 0.3 \text{ V}$	2.7 V	$2.5 \text{ V} \pm 0.2 \text{ V}$	$1.8 \text{ V} \pm 0.15 \text{ V}$
V_{mi}	1.5 V	1.5 V	$V_{CC} / 2$	$V_{CC} / 2$
V_{mo}	1.5 V	1.5 V	$V_{CC} / 2$	$V_{CC} / 2$
V_X	$V_{OL} + 0.3 \text{ V}$	$V_{OL} + 0.3 \text{ V}$	$V_{OL} + 0.15 \text{ V}$	$V_{OL} + 0.15 \text{ V}$
V_Y	$V_{OH} - 0.3 \text{ V}$	$V_{OH} - 0.3 \text{ V}$	$V_{OH} - 0.15 \text{ V}$	$V_{OH} - 0.15 \text{ V}$
V_L	6 V	6 V	$V_{CC} * 2$	$V_{CC} * 2$

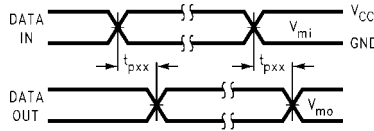

Figure 5. Waveform for Inverting and Non-Inverting Functions

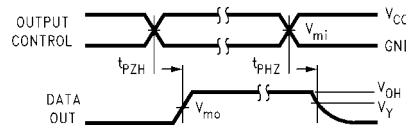

Figure 6. 3-STATE Output High Enable and Disable Times for Low Voltage Logic

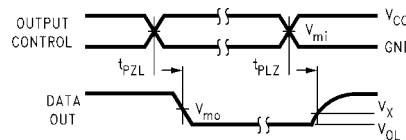

Figure 7. 3-STATE Output Low Enable and Disable Times for Low Voltage Logic

ORDERING INFORMATION

Device	Package	Shipping [†]
74ALVC16245MTDX	TSSOP48 12.5x6.1 (Pb-Free)	1000 Units / Tape & Reel

[†]For information on tape and reel specifications, including part orientation and tape sizes, please refer to our Tape and Reel Packaging Specifications Brochure, BRD8011/D.

onsemi, **Onsemi**, and other names, marks, and brands are registered and/or common law trademarks of Semiconductor Components Industries, LLC dba "**onsemi**" or its affiliates and/or subsidiaries in the United States and/or other countries. **onsemi** owns the rights to a number of patents, trademarks, copyrights, trade secrets, and other intellectual property. A listing of **onsemi**'s product/patent coverage may be accessed at www.onsemi.com/site/pdf/Patent-Marking.pdf. **onsemi** reserves the right to make changes at any time to any products or information herein, without notice. The information herein is provided "as-is" and **onsemi** makes no warranty, representation or guarantee regarding the accuracy of the information, product features, availability, functionality, or suitability of its products for any particular purpose, nor does **onsemi** assume any liability arising out of the application or use of any product or circuit, and specifically disclaims any and all liability, including without limitation special, consequential or incidental damages. Buyer is responsible for its products and applications using **onsemi** products, including compliance with all laws, regulations and safety requirements or standards, regardless of any support or applications information provided by **onsemi**. "Typical" parameters which may be provided in **onsemi** data sheets and/or specifications can and do vary in different applications and actual performance may vary over time. All operating parameters, including "Typicals" must be validated for each customer application by customer's technical experts. **onsemi** does not convey any license under any of its intellectual property rights nor the rights of others. **onsemi** products are not designed, intended, or authorized for use as a critical component in life support systems or any FDA Class 3 medical devices or medical devices with a same or similar classification in a foreign jurisdiction or any devices intended for implantation in the human body. Should Buyer purchase or use **onsemi** products for any such unintended or unauthorized application, Buyer shall indemnify and hold **onsemi** and its officers, employees, subsidiaries, affiliates, and distributors harmless against all claims, costs, damages, and expenses, and reasonable attorney fees arising out of, directly or indirectly, any claim of personal injury or death associated with such unintended or unauthorized use, even if such claim alleges that **onsemi** was negligent regarding the design or manufacture of the part. **onsemi** is an Equal Opportunity/Affirmative Action Employer. This literature is subject to all applicable copyright laws and is not for resale in any manner.

ADDITIONAL INFORMATION

TECHNICAL PUBLICATIONS:

Technical Library: www.onsemi.com/design/resources/technical-documentation
onsemi Website: www.onsemi.com

ONLINE SUPPORT: www.onsemi.com/support

For additional information, please contact your local Sales Representative at www.onsemi.com/support/sales